



Kvalita, funkčnost, odolnost byly a jsou významné benefity série Taurus GRANIT. Široká nabídka navazující na sortiment ColorONE a ColorTWO podporuje kreativní a variabilní potenciál jednotlivých projektů včetně nabídky speciálních doplňků. Všechny povrchy splňují vysoké technické nároky mezinárodních norem.

„Osvědčená kvalita.“



Quality, functionality, and durability were and are the important benefits of the Taurus GRANIT series. The wide range, building on the ColorONE and ColorTWO assortments, supports the creative and variable potential of the individual projects, including a range of special supplies. All surfaces meet the high technical requirements of international standards.

„Proven quality.“









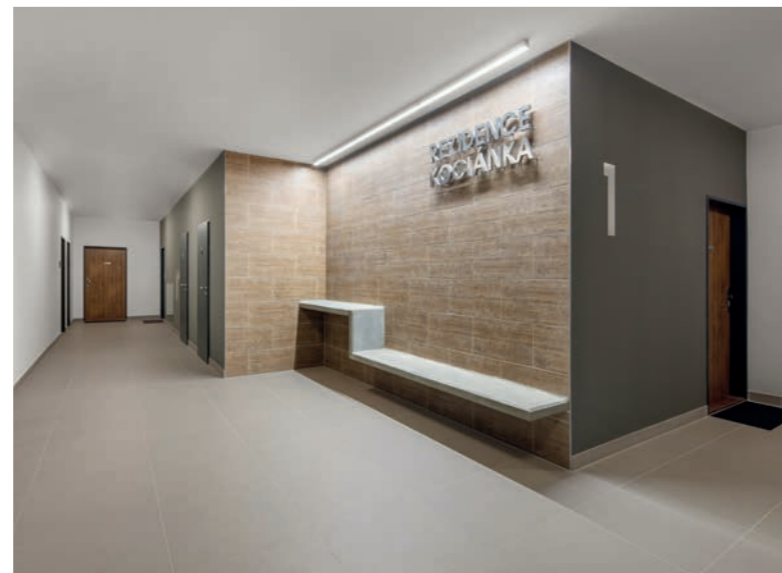





výrobek product						
STO č. 030 - 059824	schodovka step tile	schodovka step tile	ext. schodovka ext. step tile	sokl skirting plinth	sokl skirting plinth	francouzský sokl french skirting plinth
	30×60 R	30×30	30×30	60×9,5 R	30×8	30×8
	298×598×10	298×298×8	298×298×8	598×95×10	298×80×8	298×80×8
povrch surface	ABS	ABS	relief SR7	ABS	ABS	ABS
protiskluznost slip resistance	R10/B	R10/B	R11/B			
koeficient tření - za sucha sliding friction coefficient	$\mu \geq 0,7$	$\mu \geq 0,7$	$\mu \geq 0,7$			
barva color						
69 Rio Negro černá black	TCPSE069 ○ 72 ks	TCA34069 ○ 19 ks	TCV34069 ○ 44 ks	TSASZ069 ○ 50 ks	TSAKF069 ○ 19 ks	TSFKF069 ○ 30 ks
65 Antracit antracitově šedá anthracite-grey	TCPSE065 ○ 72 ks	TCA34065 ○ 16 ks	TCV34065 ○ 44 ks	TSASZ065 ○ 50 ks	TSAKF065 ○ 19 ks	TSFKF065 ○ 30 ks
76 Nordic šedá grey	TCPSE076 ○ 72 ks	TCA34076 ○ 16 ks	TCV34076 ○ 44 ks	TSASZ076 ○ 50 ks	TSAKF076 ○ 19 ks	TSFKF076 ○ 30 ks
78 Sierra světle šedá light grey	TCPSE078 ○ 72 ks	TCA34078 ○ 22 ks		TSASZ078 ○ 50 ks	TSAKF078 ○ 19 ks	TSFKF078 ○ 30 ks
60 Alaska bílá white	TCPSE060 ○ 72 ks	TCA34060 ○ 22 ks		TSASZ060 ○ 50 ks	TSAKF060 ○ 19 ks	
62 Sahara běžová beige	TCPSE062 ○ 72 ks	TCA34062 ○ 19 ks		TSASZ062 ○ 50 ks	TSAKF062 ○ 19 ks	TSFKF062 ○ 30 ks
61 Tunis tmavě béžová dark beige	TCPSE061 ○ 72 ks	TCA34061 ○ 16 ks	TCV34061 ○ 44 ks	TSASZ061 ○ 50 ks	TSAKF061 ○ 19 ks	TSFKF061 ○ 30 ks
68 Cuba hnědošedá brown-grey	TCPSE068 ○ 72 ks	TCA34068 ○ 20 ks		TSASZ068 ○ 50 ks	TSAKF068 ○ 19 ks	TSFKF068 ○ 30 ks
74 Gobi žlutá yellow		TCA34074 ○ 22 ks			TSAKF074 ○ 19 ks	
82 Jura červená red		TCA34082 ○ 22 ks			TSAKF082 ○ 19 ks	
80 Oaza zelená green		TCA34080 ○ 20 ks			TSAKF080 ○ 19 ks	
75 Biskay modrá blue		TCA34075 ○ 22 ks			TSAKF075 ○ 19 ks	
logistická data logistic information						
	6	14	13	13	23	22
	5,6	11,0	11,0	17,5	42,0	42,0
	1,08	1,27	1,18	0,74	0,55	0,53
	40	48	52	-	-	-
	43,20	60,96	61,36	-	-	-
	23,7	21,7	19,5	16,2	9,4	9,0
	21,9	17,0	17,0	21,9	17,0	17,0
	971	1 062	1 039	-	-	-

sokl s požlábkem cove skirting	sokl s požlábkem cove skirting	vnitřní roh sokl s požlábkem inside corner skirting plinth	vnější roh sokl s požlábkem outside corner skirting plinth
30×8	20×8	2,3×8	2,3×8
298×80×8	198×80×8	80×23×10	80×23×7
ABS	ABS	S	S
R10/B	R10/B		
$\mu \geq 0,6$	$\mu \geq 0,6$		
TSPKF069 ○ 28 ks	TSPF6069 ○ 22 ks	TSIRH069 ○ 46 ks	TSERH069 ○ 46 ks
TSPKF065 ○ 28 ks	TSPF6065 ○ 22 ks	TSIRH065 ○ 46 ks	TSERH065 ○ 46 ks
TSPKF076 ○ 28 ks	TSPF6076 ○ 22 ks	TSIRH076 ○ 46 ks	TSERH076 ○ 46 ks
TSPKF078 ○ 28 ks		TSIRH078 ○ 46 ks	TSERH078 ○ 46 ks
TSPKF062 ○ 28 ks	TSPF6062 ○ 22 ks	TSIRH062 ○ 46 ks	TSERH062 ○ 46 ks
TSPKF061 ○ 28 ks	TSPF6061 ○ 22 ks	TSIRH061 ○ 46 ks	TSERH061 ○ 46 ks
TSPKF068 ○ 28 ks	TSPF6068 ○ 22 ks	TSIRH068 ○ 46 ks	TSERH068 ○ 46 ks
19	28	150	100
42,0	62,5	-	-
0,46	0,45	-	-
-	-	-	-
-	-	-	-
7,8	7,6	4,5	3,5
17,0	17,0	-	-
-	-	-	-



výrobek product			
STO č. 030 - 059824	bezbariérová tvarovka rohová shower piece corner	bezbariérová tvarovka průběžná shower piece continuous	sokl žlábek skirting groove
 cm	10×10	10×10	20×7
 mm	98×98×8	98×98×8	198×70×8
povrch surface	ABS	ABS	S
protiskluznost slip resistance	R10/B	R10/B	
koeficient tření - za sucha sliding friction coefficient	$\mu \geq 0,6$	$\mu \geq 0,6$	
barva color			
69 Rio Negro černá black	TTR11069 ○ 52 ks	TTP11069 ○ 52 ks	TSZEF069 ○ 22 ks
65 Antracit antracitově šedá anthracite-grey	TTR11065 ○ 52 ks	TTP11065 ○ 52 ks	TSZEF065 ○ 22 ks
76 Nordic šedá grey	TTR11076 ○ 52 ks	TTP11076 ○ 52 ks	TSZEF076 ○ 22 ks
78 Sierra světle šedá light grey			
60 Alaska bílá white			
62 Sahara béžová beige			
61 Tunis tmavě béžová dark beige	TTR11061 ○ 52 ks	TTP11061 ○ 52 ks	TSZEF061 ○ 22 ks
68 Cuba hnědošedá brown-grey			
74 Gobi žlutá yellow			
82 Jura červená red			
80 Oaza zelená green			
75 Biskaj modrá blue			
logistická data logistic information			
	16	16	24
 ks/m²	100,0	100,0	71,0
 m²	0,16	0,16	0,34
	-	-	-
 m²	-	-	-
 kg	3,5	3,2	7,2
 kg/m²			21,2
 brutto kg	-	-	-



barvy | colors

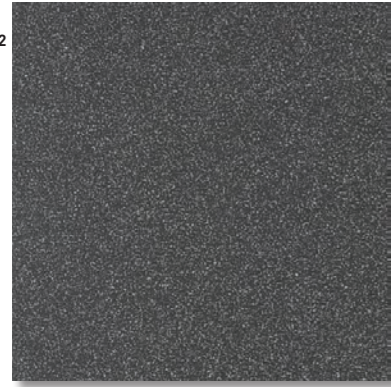
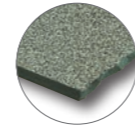

69 Rio Negro
černá | black



65 Antracit
antracitově šedá | anthracite grey



76 Nordic
šedá | grey



68 Cuba
hnědošedá | brown-grey



74 Gobi
žlutá | yellow



82 Jura
červená | red



78 Sierra
světle šedá | light grey



60 Alaska
bílá | white



62 Sahara
běžová | beige

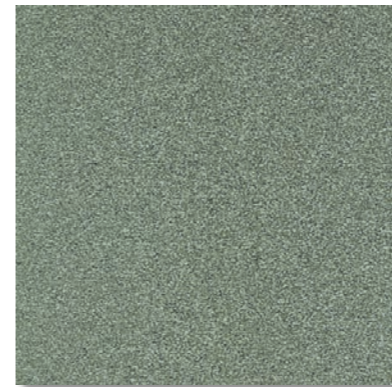

80 Oaza
zelená | green

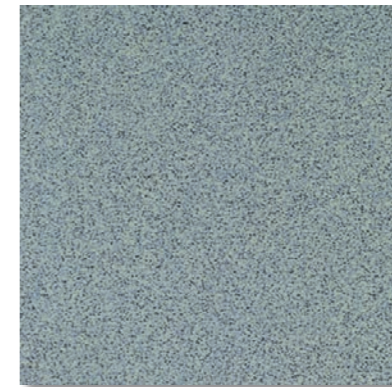

75 Biskay
modrá | blue



61 Tunis
tmavě běžová | dark beige



povrchy | surfaces



ABS

R10/B
 $\mu \geq 0,6$



relief
SR7

R11/B
 $\mu \geq 0,7$



relief
SRM

R12/B
 $\mu \geq 0,7$

ABS... - Hladký protiskluzný povrch R10/B | Smooth slip-resistant surface R10/B
SR... - Reliéfní povrch | Relief surface



doplňky | special pieces

schodovka | step tile | **TCPSE...** | 298×598×10 mm |

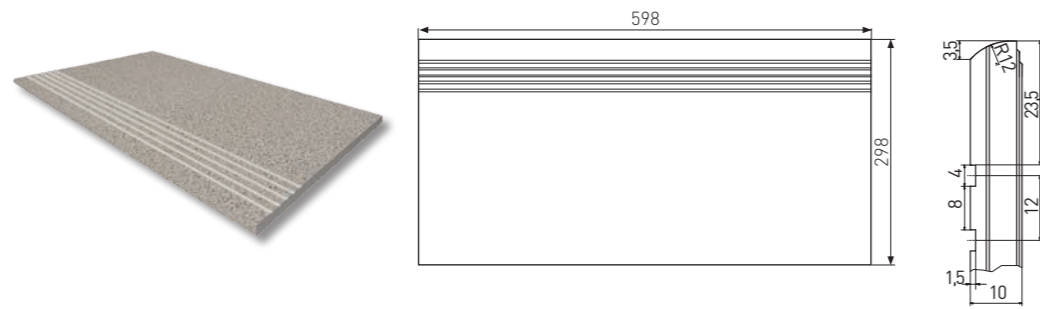

schodovka | step tile | **TCA34...** | 298×298×8 mm |

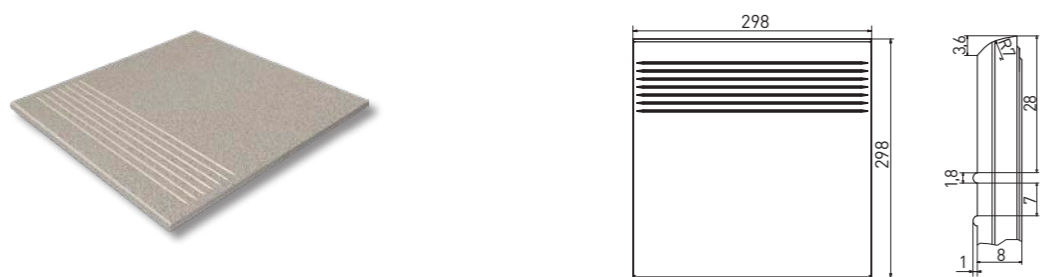

exteriérová schodovka | outside step tile | **TCV34...** | 298×298×8 mm

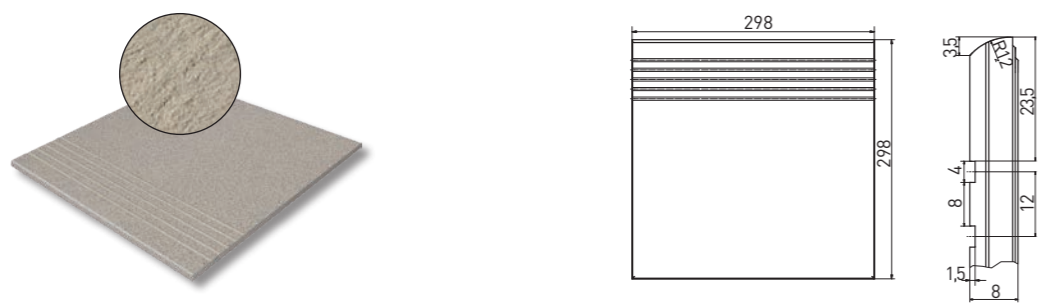

sokl | skirting plinth | **TSASZ...** | 598×95×10 mm |

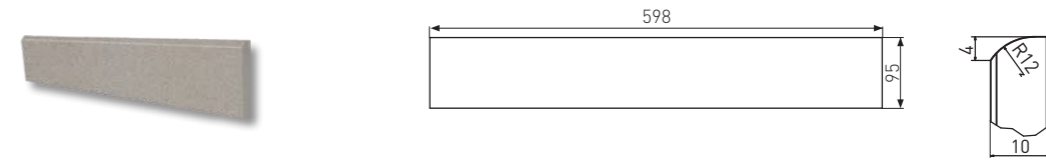

sokl | skirting plinth | **TSAKF...** | 298×80×8 mm |

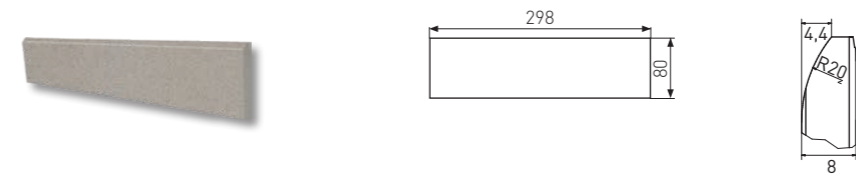

francouzský sokl | french skirting | **TSFKF...** | 298×80×8 mm |

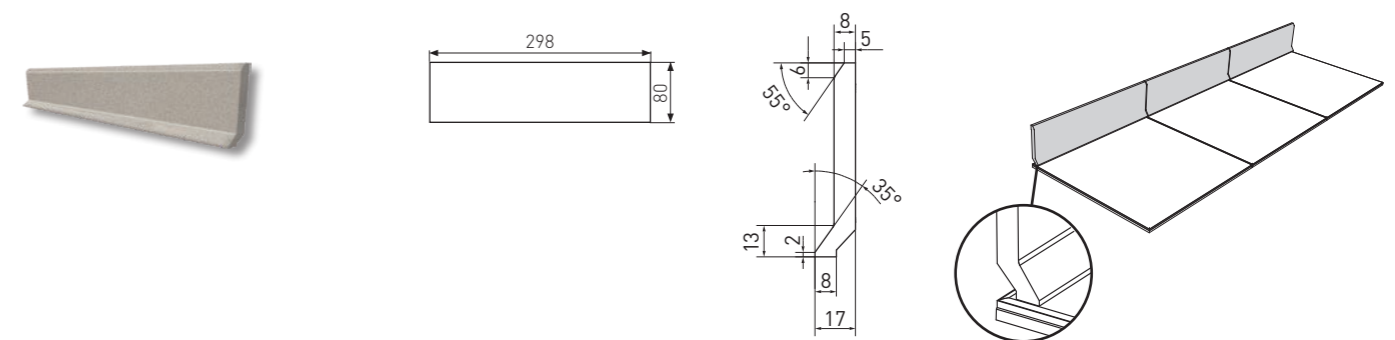



doplňky | special pieces

sokl s požlábkem | cove skirting | TSPKF... | 298x80x8 mm |

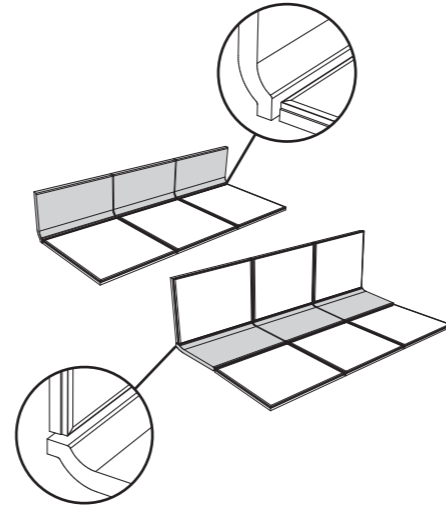
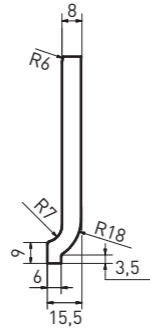
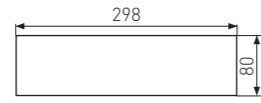

vnitřní roh sokl s požlábkem | inside corner cove skirting | TSIRH... | 80x23x10 mm

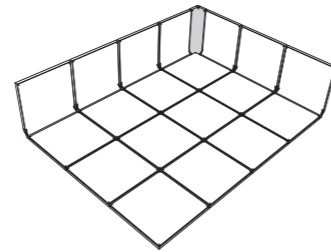
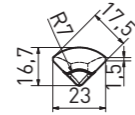
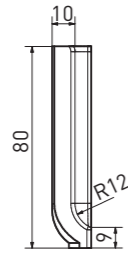

vnější roh sokl s požlábkem | outside corner cove skirting | TSERH... | 80x23x7 mm

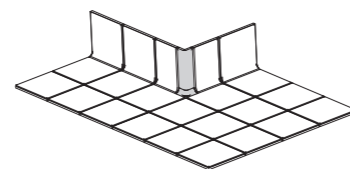
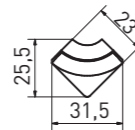
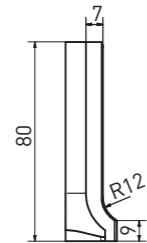

sokl s požlábkem | cove skirting | TSPF6... | 198x80x8 mm |

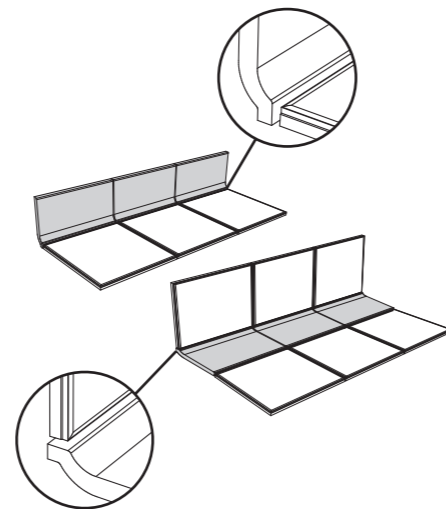
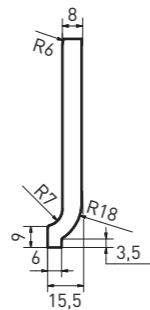
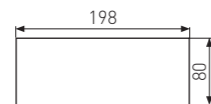

bezbariérová tvarovka rohová | shower piece - corner | TTR11... | 98x98x8 mm |

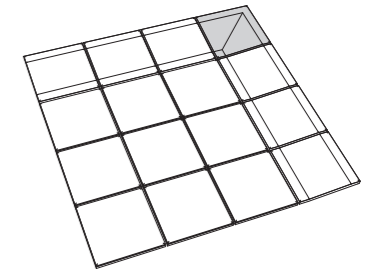
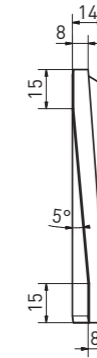
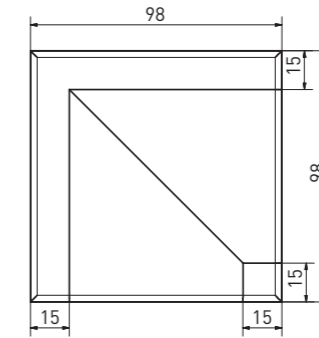
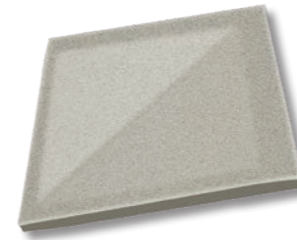

bezbariérová tvarovka průběžná | shower piece - continuous | TTP11... | 98x98x8 mm |

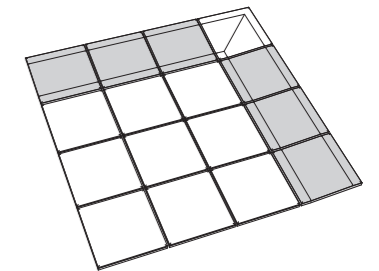
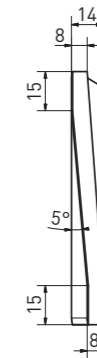
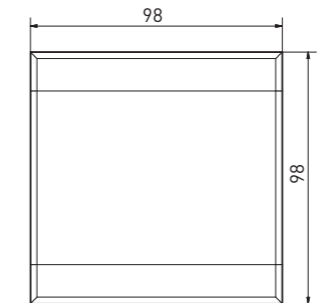

sokl - žlábek | skirting - groove | TSZEF... | 198x70x8 mm

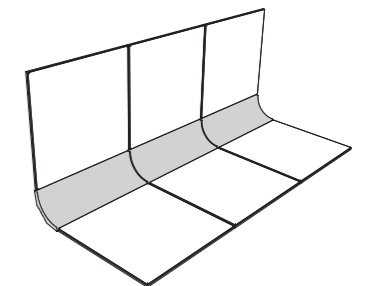
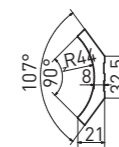
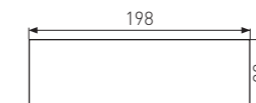

doplňky | special pieces

