



Vysoce slinuté neglazované jednobarevné dlaždice série Taurus COLOR jsou etalonem vysoké úrovně naší výroby. Nekompromisní kvalita, rozmanité povrchy dlaždic a technické doplňky umožňují použití obkladů nejen v moderních, nadčasových interiérech ale i prostorech, na které jsou kladeny vyšší funkční nároky. Součástí série jsou i keramické tvarovky pro slabozraké a nevidomé.

„Harmonie bez limitů.“



The highly sintered unglazed single-colour tiles of the Taurus COLOR series are the benchmark of our high level production. The uncompromising quality, variety of tile surfaces, and technical supplies allow the tiles to be used not only in modern, timeless interiors but also in spaces with higher functional requirements as well. The series also includes ceramic shaped bricks for the visually impaired and blind.

„Harmony without limits.“





výrobek product							
EN 14411 - G B1a	dlaždice floor tile	dlaždice floor tile	dlaždice floor tile	dlaždice floor tile	dlaždice floor tile	mozaika set 30x30 cm mosaic sheet 30x30 cm	
	60x60 R	30x60 R	30x30	20x20	10x10	5x5 R	
	598x598x10	298x598x10	298x298x8	198x198x8	98x98x8	48x48x8	
povrch surface	ABS	ABS	ABS	relief SR7	ABS	ABS	
protiskluznost slip resistance	R10/B	R10/B	R10/B	R11/B	R10/B	R10/B	
koefficient tření - za sucha sliding friction coefficient	$\mu \geq 0,6$	$\mu \geq 0,6$	$\mu \geq 0,6$	$\mu \geq 0,7$	$\mu \geq 0,6$	$\mu \geq 0,6$	
barva color							
19 Black černá black	TAK63019 88 m ²	TAKSE019 84 m ²	TAA34019 82 m ²	TR734019 84 m ²	TAA25019 82 m ²	TAA11019 90 m ²	TDM05019 68 set
07 Dark Grey tmavě šedá dark grey	TAK63007 88 m ²	TAKSE007 84 m ²	TAA34007 78 m ²	TR734007 80 m ²	TAA25007 80 m ²	TAA11007 88 m ²	TDM05007 68 set
06 Grey šedá grey	TAK63006 88 m ²	TAKSE006 84 m ²	TAA34006 78 m ²	TR734006 80 m ²	TAA25006 80 m ²	TAA11006 88 m ²	TDM05006 68 set
03 Light Grey světle šedá light grey	TAK63003 88 m ²		TAA34003 82 m ²	TR734003 84 m ²	TAA25003 82 m ²	TAA11003 90 m ²	TDM05003 68 set
11 White bílá white	TAK63011 92 m ²		TAA34011 86 m ²		TAA25011 86 m ²	TAA11011 94 m ²	TDM05011 68 set
10 Ivory slonová kost ivory	TAK63010 88 m ²		TAA34010 78 m ²	TR734010 80 m ²	TAA25010 80 m ²	TAA11010 88 m ²	TDM05010 68 set
25 Tobacco hnědošedá brown-grey	TAK63025 88 m ²		TAA34025 78 m ²	TR734025 80 m ²	TAA25025 80 m ²	TAA11025 88 m ²	TDM05025 68 set
logistická data logistic information							
	3	6	14	32	12	4	
	2,8	5,6	11,0	25,0	11,0	11,0	
	1,08	1,08	1,27	1,28	1,09	0,36	
	32	40	48	54	56	-	
	34,56	43,20	60,96	69,12	61,04	-	
	23,7	23,7	21,6	21,8	18,5	6,0	
	21,9	21,9	17,0	17,0	17,0	17,0	
	782	971	1 062	1 200	1 063	-	



výrobek product							
STO č. 030-059824	schodovka step tile	schodový prvek s podstupnicí step piece with riser	dlaždice - tvarovka special floor tile	schodovka step tile	sokl skirting plinth	sokl skirting plinth	
	30×60 R	60×5 R 60×2	30×30	30×30	60×9,5 R	30×8	
	298×598×10	598×50×10 598×20×10	298×298×9	298×298×8	598×95×10	298×80×8	
povrch surface	ABS	ABS	relief go	relief stop	ABS	ABS	
protiskluznost slip resistance	R10/B	R10/B	R11/A	R11/A	R10/B		
koeficient tření - za sucha sliding friction coefficient	$\mu \geq 0,7$	$\mu \geq 0,7$	$\mu \geq 0,7$	$\mu \geq 0,7$	$\mu \geq 0,7$		
barva color							
19 Black černá black	TCPSE019 ○72 ks	TCPVN019 ○76 set	TTG35019 ○78 ks	TTS35019 ○78 ks	TCP34019 ○44 ks	TSASZ019 ○50 ks	TSAKF019 ○19 ks
07 Dark Grey tmavě šedá dark grey	TCPSE007 ○72 ks				TCP34007 ○44 ks	TSASZ007 ○50 ks	TSAKF007 ○19 ks
06 Grey šedá grey	TCPSE006 ○72 ks				TCP34006 ○44 ks	TSASZ006 ○50 ks	TSAKF006 ○19 ks
03 Light Grey šedá light grey	TCPSE003 ○72 ks				TCP34003 ○44 ks	TSASZ003 ○50 ks	TSAKF003 ○19 ks
11 White bílá white	TCPSE011 ○72 ks				TCP34011 ○46 ks	TSASZ011 ○50 ks	TSAKF011 ○19 ks
10 Ivory slonová kost ivory	TCPSE010 ○72 ks	TCPVN010 ○76 set	TTG35010 ○78 ks	TTS35010 ○78 ks	TCP34010 ○44 ks	TSASZ010 ○50 ks	TSAKF010 ○19 ks
25 Tobacco hnědošedá brown-grey	TCPSE025 ○72 ks				TCP34025 ○44 ks	TSASZ025 ○50 ks	TSAKF025 ○19 ks
logistická data logistic information							
	6	16	9	13	13	23	
	5,6	-	11,0	11,0	17,5	42,0	
	1,08	-	0,81	1,18	0,74	0,55	
	40	-	42	52	-	-	
	43,20	-	34,36	61,36	-	-	
	23,7	15,2	18,0	19,5	16,2	9,4	
	21,9	21,9	22,2	17,0	21,9	17,0	
	971	-	780	1 039	-	-	

sokl s požlábkem cove skirting	sokl s požlábkem cove skirting	vnitřní roh sokl s požlábkem inside corner cove skirting	vnější roh sokl s požlábkem outside corner cove skirting	bezbariérová tvarovka rohová shower piece corner	bezbariérová tvarovka průběžná shower piece continuous
30×8	20×8	2,3×8	2,3×8	10×10	10×10
298×80×8	198×80×8	80×23×10	80×23×7	98×98×8	98×98×8
ABS	ABS	S	S	ABS	ABS
R10/B	R10/B			R10/B	R10/B
$\mu \geq 0,6$	$\mu \geq 0,6$			$\mu \geq 0,6$	$\mu \geq 0,6$
TSPKF019 ○28 ks	TSPF6019 ○22 ks	TSIRH019 ○46 ks	TSERH019 ○46 ks	TTR11019 ○52 ks	TTP11019 ○52 ks
TSPKF007 ○28 ks	TSPF6007 ○22 ks	TSIRH007 ○46 ks	TSERH007 ○46 ks	TTR11007 ○52 ks	TTP11007 ○52 ks
TSPKF006 ○28 ks	TSPF6006 ○22 ks	TSIRH006 ○46 ks	TSERH006 ○46 ks	TTR11006 ○52 ks	TTP11006 ○52 ks
TSPKF003 ○28 ks	TSPF6003 ○22 ks	TSIRH003 ○46 ks	TSERH003 ○46 ks	TTR11003 ○52 ks	TTP11003 ○52 ks
TSPKF010 ○28 ks	TSPF6010 ○22 ks	TSIRH010 ○46 ks	TSERH010 ○46 ks	TTR11010 ○52 ks	TTP11010 ○52 ks
TSPKF025 ○28 ks	TSPF6025 ○22 ks	TSIRH025 ○46 ks	TSERH025 ○46 ks	TTR11025 ○52 ks	TTP11025 ○52 ks
19	28	150	100	16	16
42,0	62,5	-	-	100,0	100,0
0,46	0,45	-	-	0,16	0,16
-	-	-	-	-	-
-	-	-	-	-	-
7,8	7,6	4,5	3,5	3,5	3,2
17,0	17,0	-	-	-	-
-	-	-	-	-	-



barvy | colors

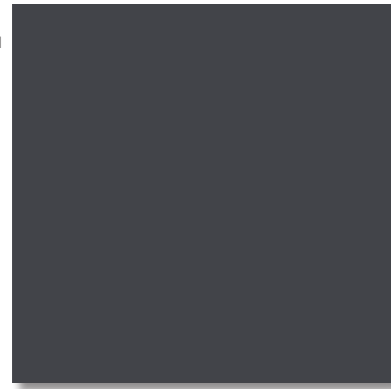
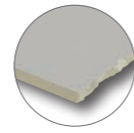

19 Black
černá | black



07 Dark Grey
tmavě šedá | dark grey



06 Grey
šedá | grey

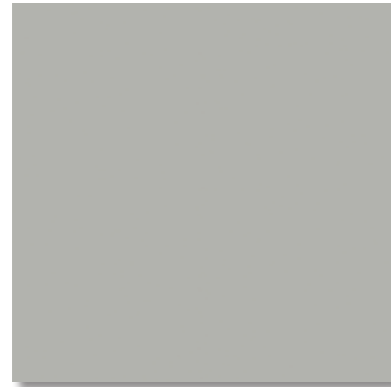

03 Light Grey
světle šedá | light grey

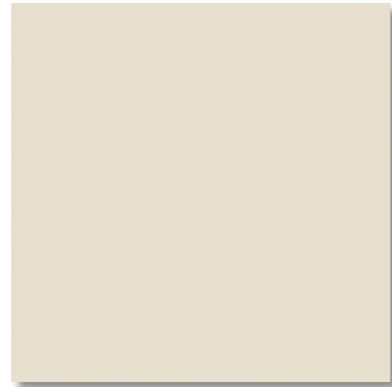

11 White
bílá | white

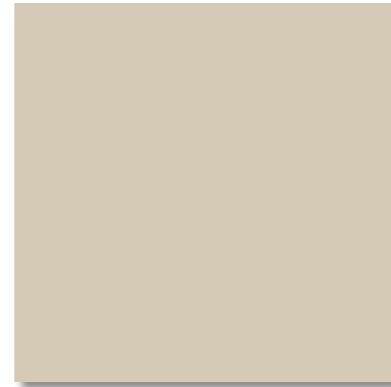

10 Ivory
slonová kost | ivory

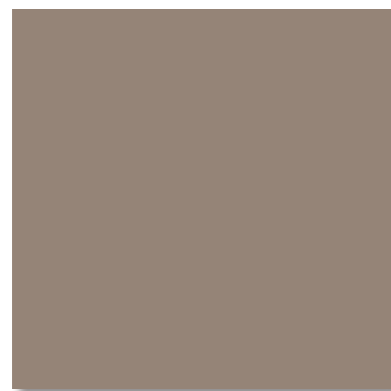

25 Tobacco
hnědošedá | brown-grey



povrchy | surfaces



ABS



relief
SR7

R10/B
 $\mu \geq 0,6$

R11/B
 $\mu \geq 0,7$



doplňky | special pieces

schodovka | step tile | TCPSE... | 298×598×10 mm |

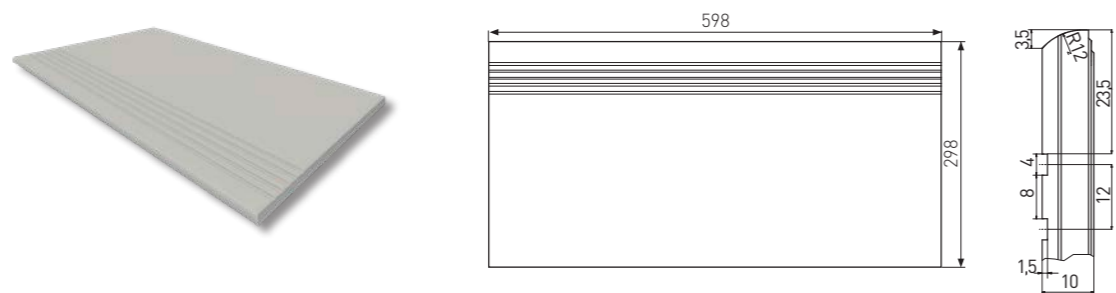

schodovka | step tile | TCP34... | 298×298×8 mm |



sokl | skirting plinth | TSASZ... | 598×95×10 mm |

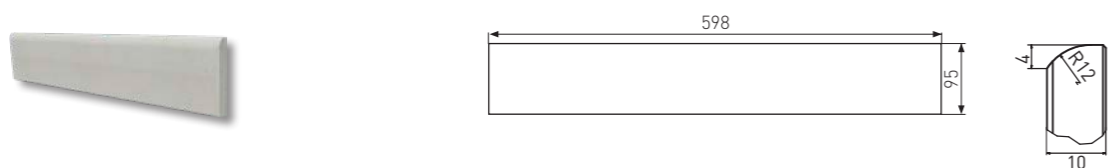

sokl | skirting plinth | TSAKF... | 298×80×8 mm |

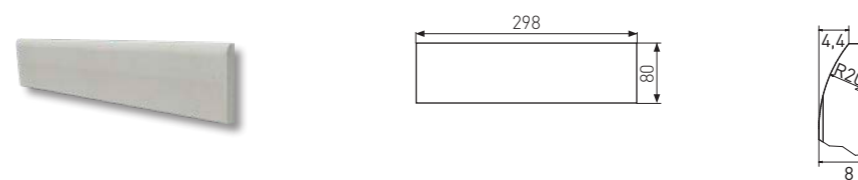

sokl s požlábkem | cove skirting | TSPKF... | 298×80×8 mm |

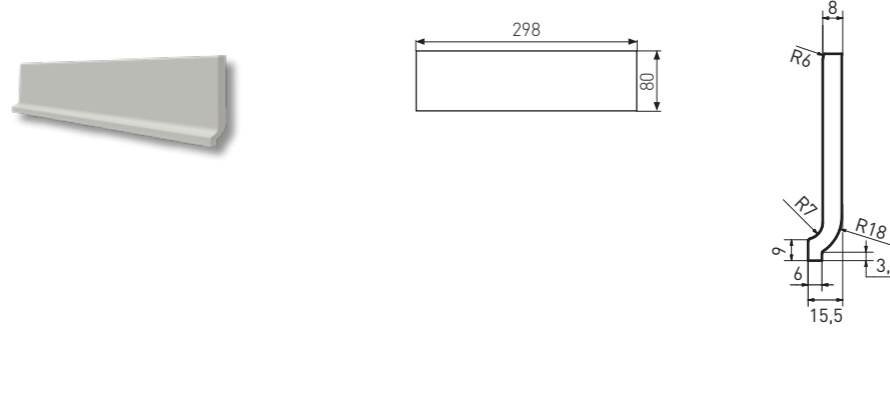

sokl s požlábkem | cove skirting | TSPF6... | 198×80×8 mm |

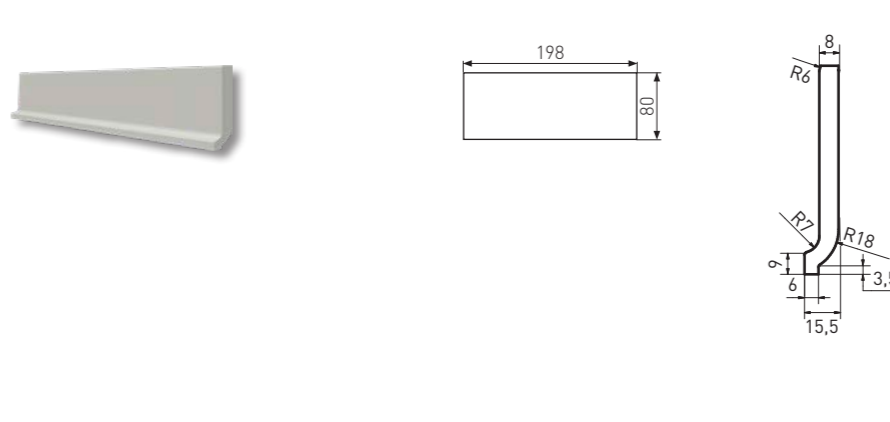



vnitřní roh sokl s požlábkem | inside corner cove skirting | **TSIRH...** | 80x23x10 mm

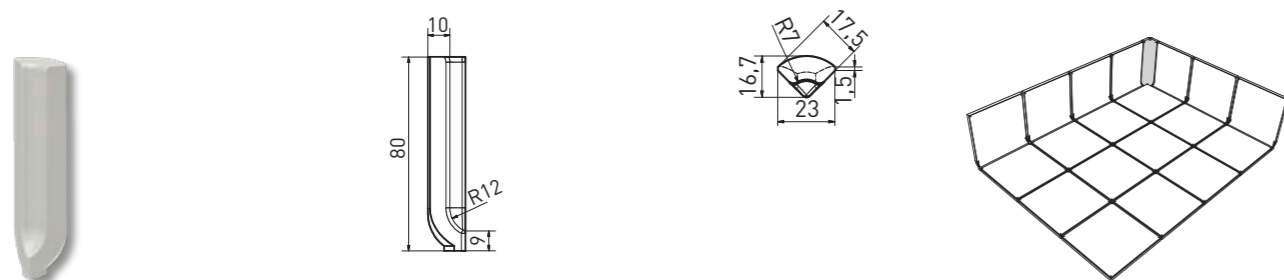

vnější roh sokl s požlábkem | outside corner cove skirting | **TSERH...** | 80x23x7 mm

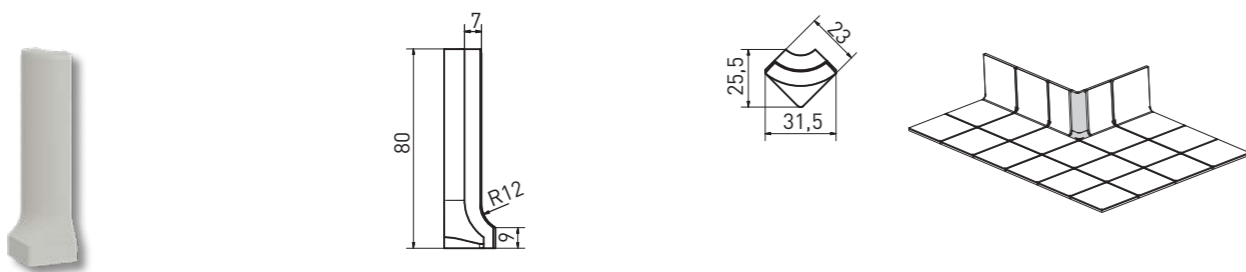

bezbariérová tvarovka rohová | shower piece - corner | **TTR11...** | 98x98x8 mm |

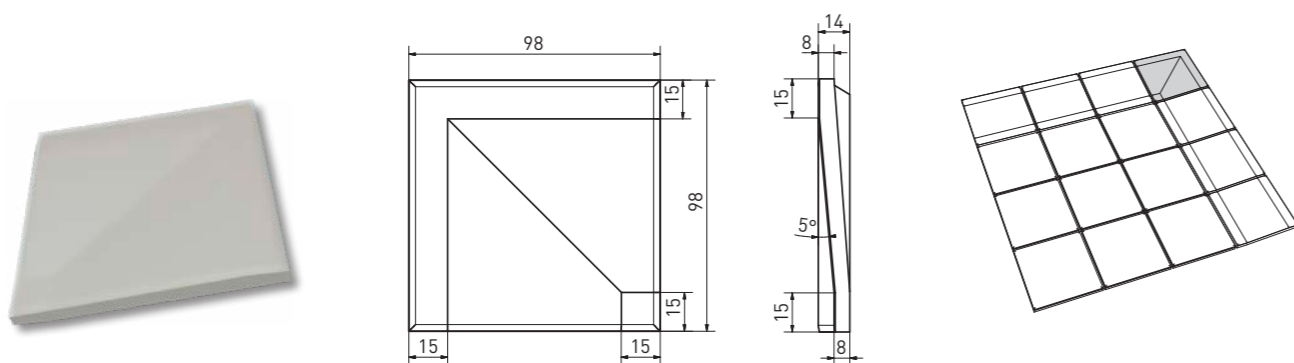

bezbariérová tvarovka průběžná | shower piece - continuous | **TTP11...** | 98x98x8 mm |

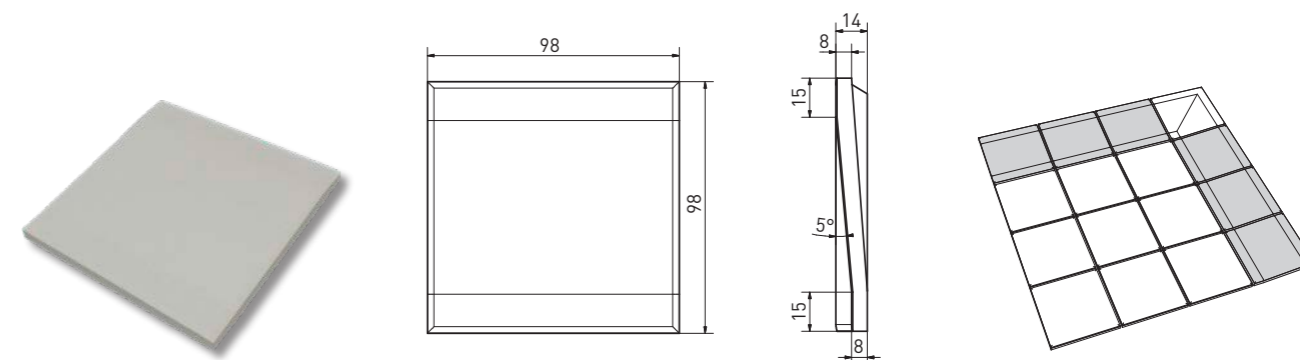

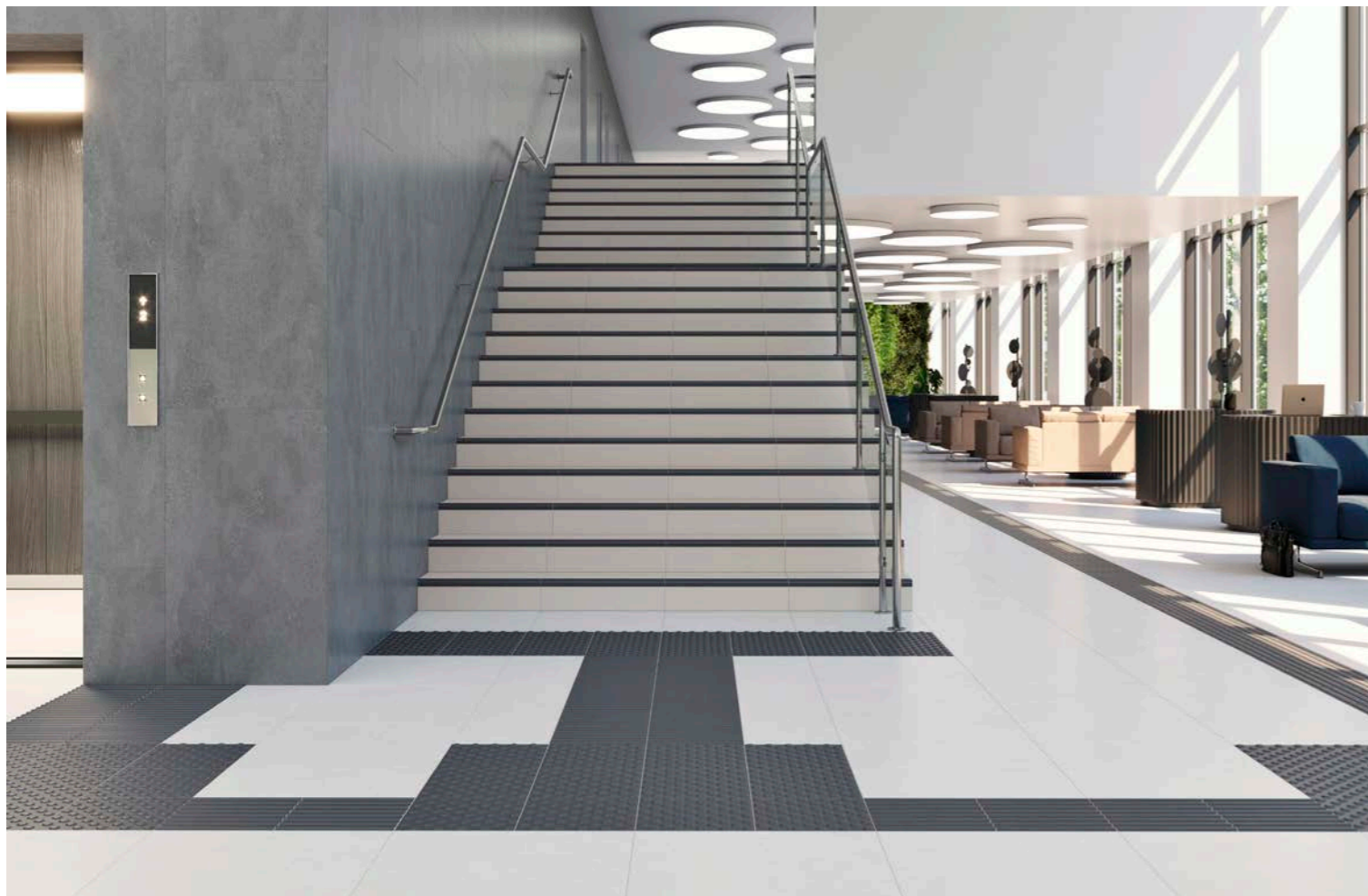
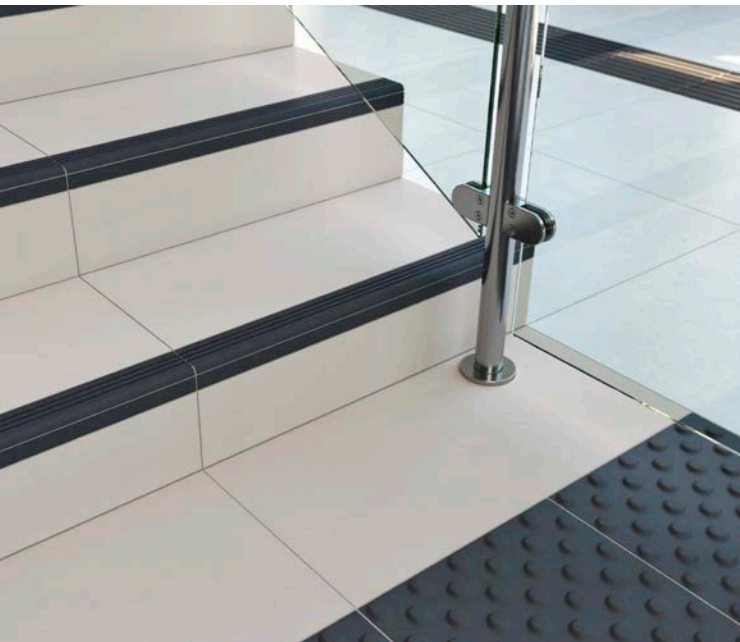
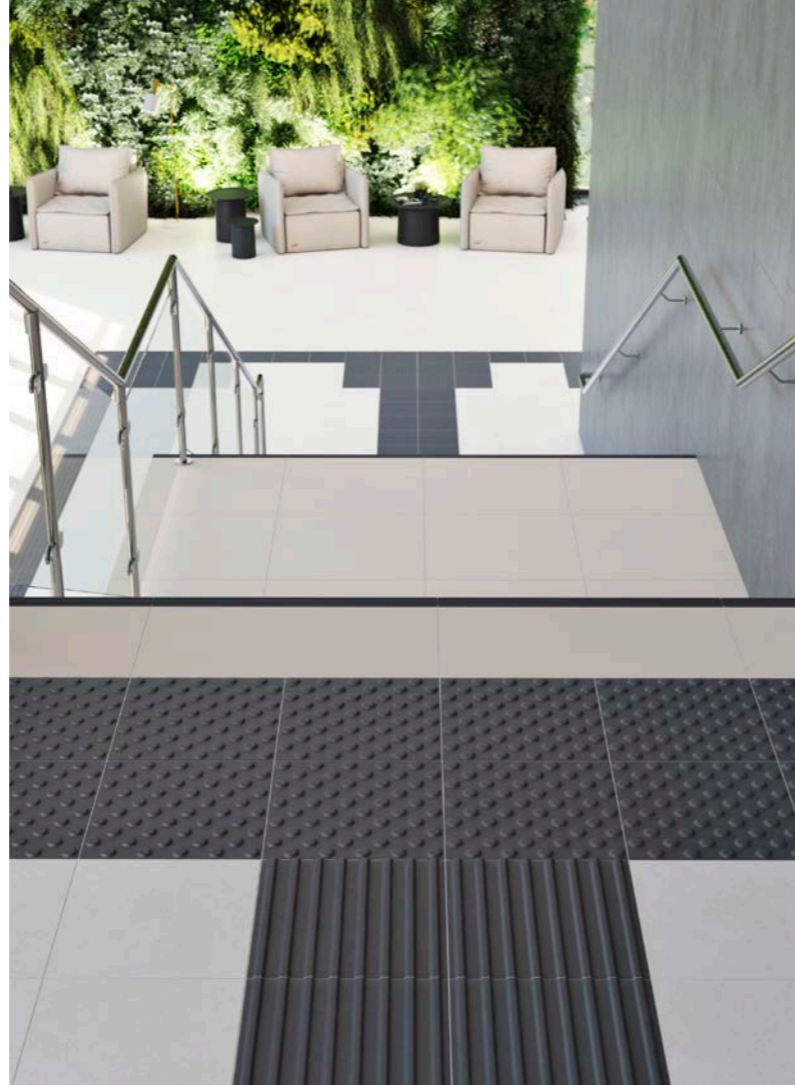

doplňky | special pieces

schodový prvek s podstupnicí | step piece with riser | **TCPVN...** | 598x50x10 mm | 598x20x10 mm | 

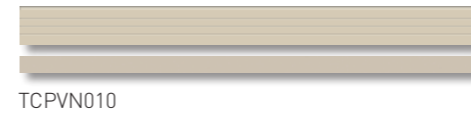

TCPVN010



TCPVN019

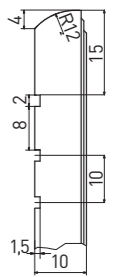
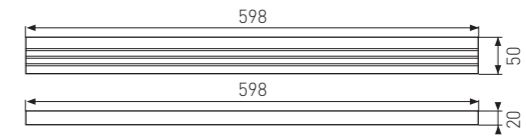
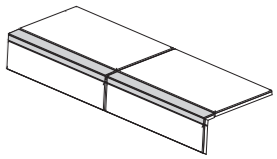

speciální tvarovky pro nevidomé | special ceramic shaped tiles for the visually impaired persons

relief go



TTG35010



TTG35019

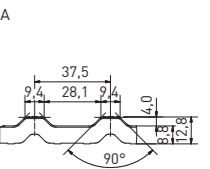

relief stop

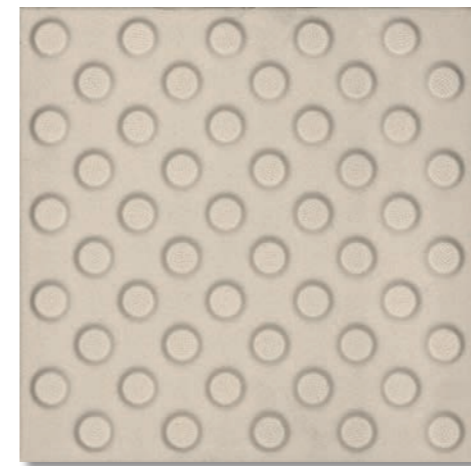

TTS35010

slonová kost | ivory

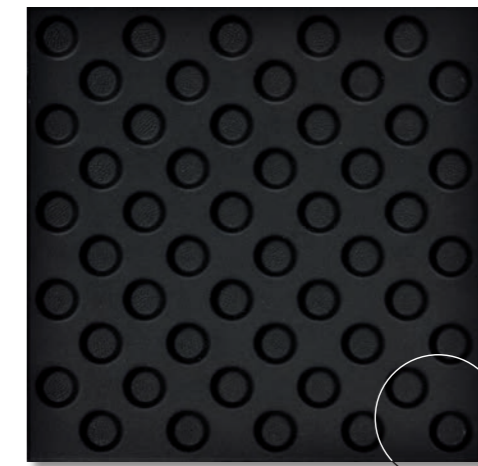

TTS35019

černá | black

