

2024

RAKO[®]

Technical
catalogue

**TECHNICAL
CATALOGUE
2024**

Contents

	Page
1. BASIC PRODUCT CATEGORIES ACCORDING TO THEIR UTILITY VALUES	3
1.1 RAKO HOME/OBJECT CERAMIC WALL AND FLOOR TILES	3
1.2 RAKO SYSTEM BUILDING CHEMISTRY FOR LAYING OF CERAMIC TILES	3
2. CLASSIFICATION AND IDENTIFICATION OF CERAMIC PRODUCTS ACCORDING TO WATER ABSORPTION	4
2.1 RAKO CERAMIC TILES AND ACCESSORIES - IDENTIFICATION SYSTEM AND APPLICATION RECOMMENDATION	4
2.2 DIMENSIONS AND GEOMETRIC PARAMETERS	6
3. PROPERTIES OF CERAMIC TILES	7
3.1 WATER ABSORPTION	7
3.2 FROST RESISTANCE	7
3.3 ABRASION RESISTANCE (PEI)	7
3.4 DEEP ABRASION RESISTANCE	8
3.5 SURFACE HARDNESS ACCORDING TO THE MOHS HARDNESS SCALE	8
3.6 SLIPPERINESS	8
3.7 BREAKING RESISTANCE	14
3.8 THERMAL PROPERTIES	15
3.9 CHEMICAL PROPERTIES	15
3.10 ELECTRICAL PROPERTIES	16
3.11 HYGIENIC PROPERTIES	17
3.12 OPTICAL PROPERTIES	17
3.13 ADHESION OF CERAMIC TILES	20
3.14 REACTION TO FIRE	20
4. LAYING OF TILES	24
4.1 SUBSTRATE PREPARATION BEFORE LAYING	24
4.2 TILE CUTTING AND DRILLING	25
5. CONTACT LAYING	26
5.1 CERAMIC TILES BONDING	26
5.2 UNDERFLOOR HEATING	30
5.3 STAIRS	33
5.4 APPLICATION OF CERAMIC PLINTHS	35
5.5 BARRIER-FREE SOLUTIONS FOR AREAS SUBJECT TO WATER LOADS	38
5.6 BARRIER-FREE SOLUTIONS FOR THE BLIND AND PARTIALLY SIGHTED	39
6. GROUTING OF TILES AND DILATATION	40
6.1 NON-FLEXIBLE JOINTS	40
6.2 FLEXIBLE EXPANSION JOINTS	40
7. CONTACT LAYING PROCEDURES	42
7.1 WATERPROOFING THE SHOWER ENCLOSURE	42
7.2 SHOWER ENCLOSURE SEALING	44
8. DRY TILE-LAYING TECHNIQUE	47
8.1 LAYING INTO LAWNS AND GRAVEL	47
8.2 LAYING ON PEDESTALS	48
8.3 PROCEDURES FOR DRY LAYING	50
9. INSPECTION OF THE INSTALLATION AFTER LAYING	56
10. MAINTENANCE AND CLEANING OF CERAMIC WALL AND FLOOR TILES	57
11. SHOPPING TIPS AND CONSIDERATION BEFORE LAYING	59
12. CERTIFICATION OF PRODUCTS, QUALITY MANAGEMENT SYSTEM, AND ECOLOGICAL EVALUATION	60
13. WARRANTY CONDITIONS	64

1. BASIC PRODUCT CATEGORIES ACCORDING TO THEIR UTILITY VALUES

1.1 RAKO HOME/OBJECT CERAMIC WALL AND FLOOR TILES

From the perspective of users, the offer of RAKO ceramic wall and floor tiles is divided into two groups. **RAKO HOME** household line of ceramic products is intended for final users, while the **RAKO OBJECT** system RAKO HOME represents a wide assortment of ceramic wall and floor tiles with the best price-quality ratio, for complete solutions of bathrooms, floors, and kitchens of home interiors, balconies, terraces, and outdoor swimming pools. The broad range of RAKO OBJECT ceramic products introduces a complete solution to architects, designers, and experts, focusing on high technical requirements. The complete range of products can be found in the RAKO HOME | OBJECT catalogue, or at www.rako.eu.

1.2 RAKO SYSTEM BUILDING CHEMISTRY FOR LAYING OF CERAMIC TILES

The complete offer of building chemistry products, which presents the optimal solution for laying of ceramic floor and wall tiles, from housing interiors to demanding applications for tiling of swimming pools, enclosed balconies, terraces, or industrial floors. The catalogue of RAKO SYSTEM building chemistry products includes materials for preparation of the base (levelling materials, penetration coatings), water-proofing stoppers, adhesive and grouting materials (cement, epoxy, silicone and polyurethane), as well as fixtures for the maintenance of tiled surfaces. We recommend consulting specific technologies with the technical consultants of the project team. For contact details and other information please visit www.rakosystem.cz, or at www.rako.eu.



2. CLASSIFICATION AND IDENTIFICATION OF CERAMIC PRODUCTS ACCORDING TO WATER ABSORPTION

2.1 RAKO CERAMIC TILES AND ACCESSORIES - IDENTIFICATION SYSTEM UND APPLICATION RECOMMENDATION

Recommended use of available types of ceramic tiles:

Fully vitrified floor tiles with catalogue codes Dxxxxxxx, Gxxxxxxx, Txxxxxxx

Fully vitrified dry-pressed frost-resistant ceramic tiles with very low water absorption $E \leq 0,5 \%$, made in compliance with EN 14411 BIa GL/UGL. The products are intended mainly for floor tiling exteriors and interiors exposed to climatic effects and subjects to extreme mechanical stress, abrasion and pollution. The tiles with declared anti-slip surface finish must be used for floors with the risk of slipping pursuant to the applicable regulations. The products marked with **R** icon are rectified and besides the accurate dimensions (calibre), they also have improved geometrical parameters (linearity, rectangularity), allowing precise laying with a joint of 2 mm at minimum and format combinations.

Wall tiles with a catalogue code Wxxxxxxx

Ceramic dry-pressed glazed wall tiles with water absorption $E > 10 \%$, made in compliance with EN 14411 BIII GL. They are designed for tiling of interior walls and not suitable for exposure to climatic effects, frost, permanent effects of water, acids and alkali, their vapours and abrasives. **In environments where porous wall tiles will be exposed to the direct action of water, in shower boxes etc., it is necessary to use a CG2WA type grouting material with reduced water absorption.** With respect to used glaze typology (transparent, semi-transparent), transient dark colouring of the tile may appear, as it is influenced by humidity penetrating into the body of the tile. The colouring may further be supported with water permeability of the joints, insulation layers in the base (water is held between the insulation layer and the glaze), and high air humidity in bathrooms with insufficient ventilation. However, this transient colouring does not represent a defect of the product. Large-format wall tiles (30 × 60, 30 × 90 and 40 × 120 cm) are manufactured also in a rectified design. In addition to accurate dimensions (calibre), they also have improved geometrical parameters (linearity, rectangularity), allowing precise laying with a joint of 2 mm at minimum and format combinations.

Glazed tiles with catalogue code GARJDxxx

are dry-pressed ceramic tile elements with a water absorption of $0.5\% < E \leq 3\%$ manufactured according to EN 14 411:2016 BIb GL, Annex H. The tiles can be used to clad interior walls and exterior facades that are exposed to the weather. Examples of their universal use are walls of bathrooms, kitchens, corridors, offices, external facades, saunas, showers, swimming pools and public buildings and food processing plants. The tiles are produced in a wide range of colours with a glossy surface in relief. These products are not intended for flooring due to the reduced mechanical resistance of the glossy glaze.

Non-ceramic accessory materials – glass with a catalogue code Vxxxxxxx, natural stone with a catalogue code Sxxxxxxx

Unique accessory materials complementing ceramic wall tiles. Properties of these materials and their characteristic differences in colour, structure and other properties are determined by the production technology or by their natural origin.

POOL vitrified extruded elements and special pieces, catalogue code: XPxxxxxx

Highly vitrified extruded glazed frost-resistant ceramic products with very low absorption $E \leq 0.5 \%$, in compliance with EN 14411 Ala GL. They are suitable mainly for professional solutions of large public swimming pools as well as for private indoor and outdoor swimming pools.

Use of RAKO wall and floor tiles according to the water absorption parameter:

Types of ceramic wall and floor tiles, and their use according to EN 14411	Water absorption	Hardness class according to the Mohs hardness scale	Frost resistance	Application in interiors	Application in exteriors	Identification system RAKO - first position of the catalog number
Fully vitrified dry pressed glazed floor tiles (G BIa GL)	$\leq 0,5 \%$	5	YES	Walls, floors	Walls, floors	D, G
Fully vitrified dry pressed unglazed floor tiles (G BIa UGL)	$\leq 0,5 \%$	7	YES	Walls, floors	Walls, floors	T, D*
Compact floor tiles dry pressed (H BIb GL)	$0,5 \% < E \leq 3 \%$	3	YES	Walls	Walls	GARJDxxx
Dry pressed wall tiles (L BIII GL)	$> 10 \%$	3	NO	Walls	-	W
Fully vitrified glazed drawn tiles	$\leq 0,5 \%$	5	YES	Walls, floors	Walls, floors	XP

D* unglazed tiles decorated

Product identification - production batches

All ceramic tile products are made in batches which may differ from each other in colour shade and dimensions. The batches are identified in client documentation, on pallets, cardboard boxes, on the edge of the tile (rectified tiles only) and in delivery notes. In addition to the catalogue number, name of the series and the type of surface or product, packages include identification of shade, declared dimensions, calibre, quality, glazed or unglazed typology and EAN code.

Tiles from individual batches with different identification of the colour shade or declared size shall not be used on the same surface. The colour shade on the cardboard packaging is marked with a combination of two or three characters, and the size is indicated as a code number in mm (e.g. **8** refers to work size of e.g. 598 × 598 × 10 mm).

Fig. 1 Identification of the colour shade, size, quality, and typology (GL or UGL) is printed on a cardboard packaging and on a pallet.

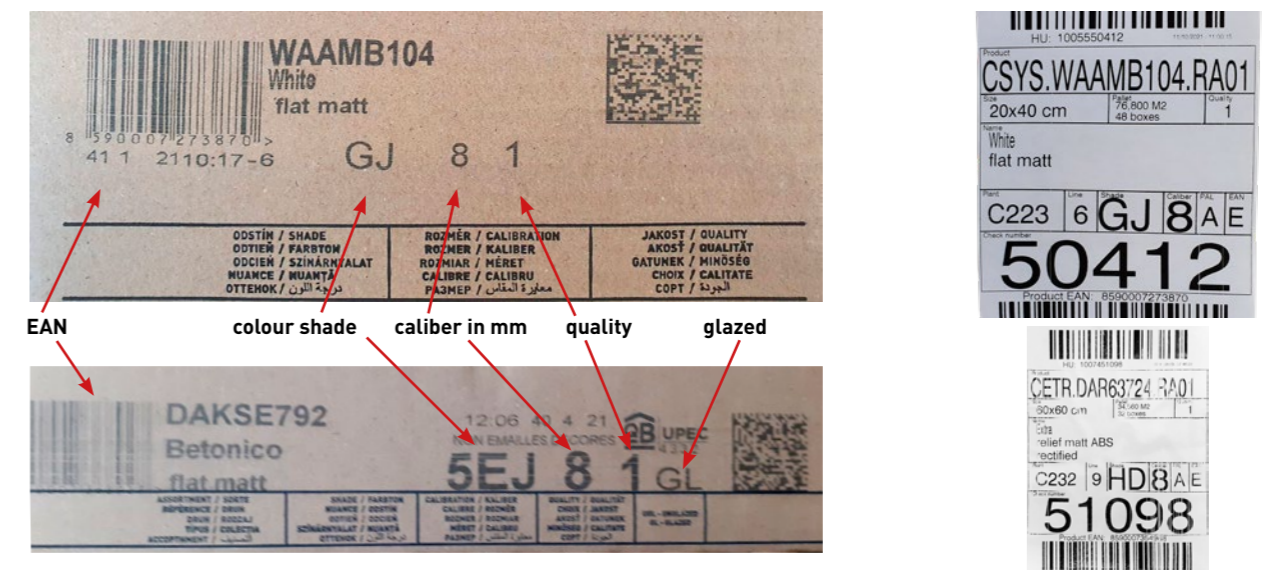

Variation of colour shades

Intentional variation of colour shades and surface textures reflects preferences for natural décors and digital printing capabilities, and the variation should not be confused with the product's unique colour shade within the same batch. Intentional variation of shades is defined as V1–V4 on a scale.

- V1** – minimum differences, single-colour tiles
- V2** – small differences in colour and texture between individual tiles
- V3** – big differences in colour, texture, and surface (for example, 8 colour types)
- V4** – big and completely random differences in colour, texture, and surface between individual pieces (up to 16 colour types)

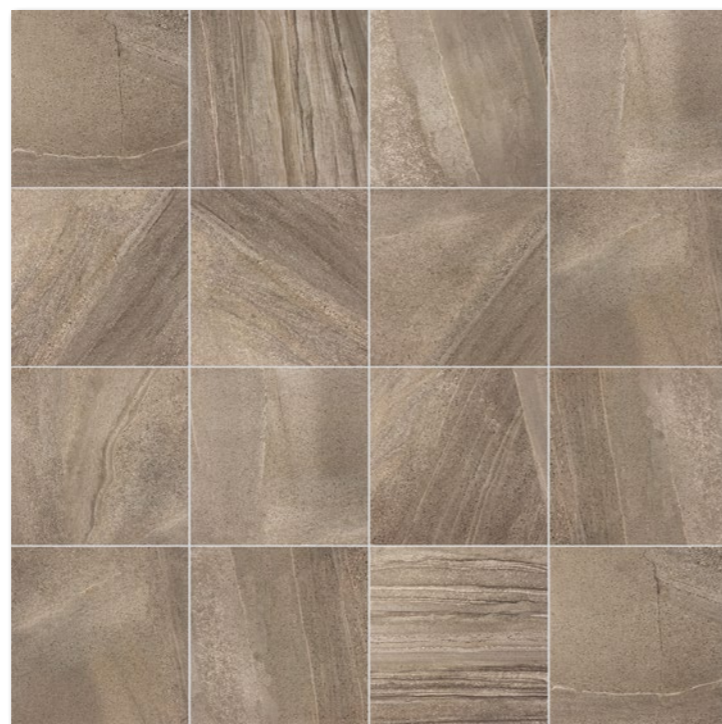

In order to achieve a balanced appearance of natural décors, individual tiles should be turned by 90° or by 180°. Before laying, individual tiles should be dry placed to avoid placing identical patterns next to one another. The resulting surface can be combined according to the inspirational real projects available at www.rako.eu.

Certifications and Declarations of performance

Systems for assessing and verifying stability of structural products' properties: System 4 annex V point 1.5 Regulation of the European parliament and the Commission (EU) No. 305/2011 dated 9th March 2011
Declarations of performance are available to download in several languages at: www.rako.eu

Completion of products

Products are packed in paper cartons, placed on a wooden EUR pallet (120 × 80 cm), and floor tiles 120 × 120 cm on a wooden pallet with sides (122 × 143 × 70 cm), fixed with plastic tapes and protected with plastic foil.

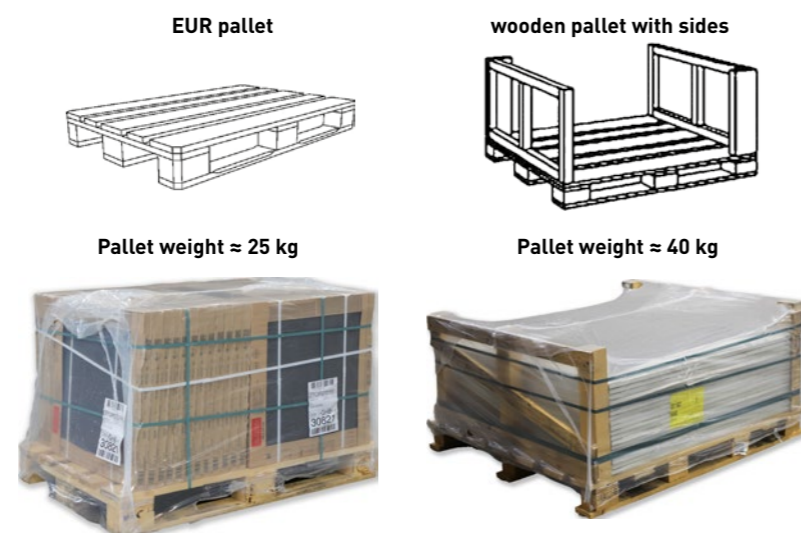

2.2 DIMENSIONS AND GEOMETRIC PARAMETERS

Nominal and declared size

Ceramic tiles are identified according to EN 14411 with **nominal sizes** in cm, for example: 10 × 10, 20 × 20 cm. Specific manufactured sizes – **declared dimensions (W)** of ceramic tiles are shown on packaging in mm. Methods to determine geometric parameters of ceramic tiles and allowed deviations from the declared sizes are described in the standard EN ISO 10545-2. The declared size is specified on packaging and delivery notes in millimetres. Accurate values and tolerance for all types of LASSELSBERGER, s.r.o. products are provided in information annexes to the catalogue RAKO HOME | OBJECT.



Rectified Tiles

Low-absorption floor tiles of sizes 10 × 10, 20 × 20, 22.5 × 45, 22.5 × 22.5, 15 × 45, 45 × 45, 15 × 60, 30 × 60, 60 × 60, 20 × 80, 40 × 80, 80 × 80, 20 × 120, 30 × 120, 60 × 120 and 120 × 120 cm and wall tiles of sizes 30 × 60, 30 × 90 and 40 × 120 cm are mainly offered with rectified edges, which are ground with high precision and allow installation with a narrow joint from 2 mm. In the catalogue, **rectified (ground) tiles are always marked with the letter R icon**. The ground edges of the rectified wall tiles and floor tiles are fragile and require careful and cautious handling.

Non-rectified Tiles

Non-rectified tiles of the ColorTWO, POOL and TAURUS series included in the RAKO OBJECT catalogue are mostly made in module dimensions 8. In addition there are non-rectified wall tiles with module dimension 8 in the RAKO HOME catalogue in the sizes of 15 × 15, 20 × 20, 20 × 40, 20 × 60 and 30 × 60 and non-rectified floor tiles in the sizes of 10 × 10, 20 × 20, 10 × 20, 10 × 30, 30 × 30, 45 × 45 and 30 × 60 cm. **For non-rectified tile elements including accessories, the decisive role is played by the declared dimensions of the product contained in the product batch, which are important when using several types of ceramic tile elements on one surface and for maintaining the same joint width. Owing to natural dimensional inaccuracies of the non-rectified products, we however do not recommend installing tiles with a joint narrower than 2 mm. Dimensional differences in the case of very narrow joints are discernible in accordance with the standard. For this reason, in the case of installation of non-rectified tile elements we recommend a joint width of about 3–4 mm.**

Module sizes

Module sizes, e.g. M 10 × 10, M 20 × 20 cm, are suitable for combinations of tiles of different formats on one surface while keeping running joints. For example size 8 (598 × 598, 298 × 598 mm) allows modular combinations of these sizes of polished, lapped and standard tiles or rectified tiles into a single surface with continuous joints. **However, joint widths narrower than 2 mm reduce the capability to absorb the tension between the base and the tile itself. As a rule, we do not recommend installation without joint spacing. This mode of installation completely eliminates the absorption of the tension between the base and the tile; moreover, the dirt that collects in the joints cannot be removed.** Ceramic products with module sizes consist of multiples of the basic sizes. The identification of the product size also includes the width of a uniform joint in order to achieve uniform joints on a surface made of different tile sizes.

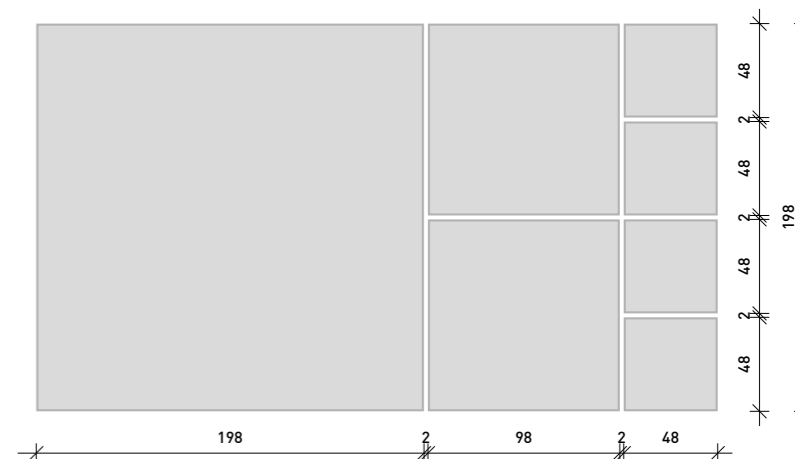

Mosaics, decors

These are offered for example in nominal sizes 2.5 × 2.5, 5 × 5, 5 × 10 cm etc. **The sizes of the individual types of mosaic, décors and accessories are derived from the basic tile sizes to which their dimensions are harmonised.** Individual elements are glued on plastic or paper mesh – sets in the sizes of 30 × 30, 30 × 60 cm etc.,. If necessary, the mesh of the set may be cut into individual bands or listellos. The size of the sets and joints may be corrected to suit adjacent elements and large tiles. Permitted deviations from the declared sizes are described in the Technical Construction Regulations – STO – see the website www.rako.cz/en/download.

Dimensional and flatness tolerances

Deviations from the declared dimensions and flatness of ceramic tiles are defined by EN 14411.LB values achieved, is included in the RAKO HOME | OBJECT catalogue. Applies to length and width, thickness, straightness of cheekedge straightness, squareness and flatness. The requirements of the standard regarding these parameters can be found in the table of technical characteristics on pages 21–23.

Surface quality

The assessment of dimensional and geometric parameters according to EN ISO 10545-2 includes surface finish, which specifies that at least 95 % of the ceramic tiles are free from visible surface defects.

3. PROPERTIES OF CERAMIC TILES

3.1 WATER ABSORPTION



Water absorption is the most important property in selection of a tiling material for a specific environment. Water absorption is ability of a fired ceramic product to absorb liquid, and is a percentage expression of the ratio of water absorbed by a test specimen and the weight of the dry specimen under the conditions of test standard EN ISO 10545-3. Ceramic tiles with low water absorption show best operating characteristics and resistance to the most severe operating conditions, especially frost resistance.

3.2 FROST RESISTANCE



For exteriors it is necessary to use only frost resistant ceramic tiles, which resist long action of frost and weather. Frost resistance is tested by stated number of frosting and defrosting cycles under specified conditions according to standard EN ISO 10545-12. There is a relation between frost resistance and water absorption. The lower is water absorption the higher is frost resistance. Ceramic wall tiles EN 14411 BIII are not frost resistant and therefore are suitable for interiors only. For exterior floors and walls we recommend using highly resistant unglazed or glazed vitrified tiles, group BIa according to EN 14411.

3.3 ABRASION RESISTANCE (PEI)

PEI

Resistance to surface wear – abrasion resistance – is the ability of glazed ceramic products to resist certain abrasives under given conditions. Glazed floor tiles are divided into different resistance classes. The abrasion resistance of glazed floor tiles is determined according to EN ISO 10545-7 with aluminiumoxid-grains, balls of steel and water in an eccentric circling system in the PEI-wet-test. Artificial wear is simulated in an eccentrically circulating system, using particles of aluminium oxide, steel beads, and water. The tested tiles are then classified according to the speed during which the profile remains undamaged into categories PEI 1 to PEI 5. Ceramic tiles provide much higher abrasion resistance compared to laminate floorings.

- **Class PEI 1**
Glazed ceramic floor tiles for low interior foot traffic without the likelihood of scratching. Application in bathrooms, bedrooms, apartments except in entrance halls, terraces without the danger of dirt being brought in from outdoors.
- **Class PEI 2**
Glazed ceramic floor tiles for medium interior foot traffic. Application in bathrooms and apartments except in entrance halls and similar rooms with heavier traffic and a danger of dirt being brought in from outdoors.
- **Class PEI 3**
Glazed ceramic floor tiles for medium but heavier foot traffic with slight risk of abrasion, such as living rooms, hotel bathrooms.
- **Class PEI 4**
Glazed ceramic floor tiles for medium to high foot traffic with risk of abrasion and normal work shoes in entrance halls, commercial rooms and offices.
- **Class PEI 5**
Glazed ceramic floor tiles for use in high foot traffic areas such as doorways, stores, corridors, garages, railway stations and airport halls.

3.4 DEEP ABRASION RESISTANCE



Deep abrasion resistance (deep abrasive power) is ability of unglazed ceramic products to resist abrasion under specified conditions. Test principle is to determine the amount of material of the body on the tile face abraded away by grinding action of a test tool under specified conditions - according to standard EN ISO 10545-6. For with heavy loaded tiles (industry, warehouses, food-processing plants, railway stations, passageways, and supermarkets), the RAKO brand vitrified unglazed tiles are recommended.

3.5 SURFACE HARDNESS ACCORDING TO THE MOHS HARDNESS SCALE



For the evaluation of the surface hardness against wearing, the Mohs' material hardness scale 1-10 according to the ČSN EN 101 is used.

3.6 SLIPPERINESS





This is one of the most important surface properties of ceramic floor tiles, which determines the suitability of selected floor tiles for a particular room, and which guarantees safe movement of people. Requirements on the anti-slip properties of floors are specified by national regulations, for example in the Czech Republic by Public Notice No. 268/2009 and ČSN 74 4505 and ČSN 72 5191 standards, which should be complemented by safety regulations ASR A1.5, which can be recommended for buildings throughout Europe (see Table 1). In Germany, these requirements are set out in Technische Regel für Arbeitsstätten – ASR A1.5: Fußböden.

Slip resistance of the ceramic tiles is determined by the method ASR A1.5 stated by the following standards:

- **CEN/TS 16 165:2022** Determining slip resistance of pedestrian surfaces – Methods of evaluation, Determining slip resistance
- **DIN 51 097** Determination of sliding properties for wet surfaces for bare foot
- **DIN 51 130** Determination of sliding properties for working areas and surfaces with increased risk of slip
- **ASR A1.5** Safety regulations
- **ANSI A137.1** Determining slip resistance according to the standard valid in North America

According to ČSN 72 5191 and Regulation ASR A1.5 (DIN 51 130) anti-slip floor tiles according to their slip angle for work floors should be used.

The following charts contain a summary of the tested anti-slip values of RAKO HOME and RAKO OBJECT tiles incl. the products marked with  with the latest generation of so-called sprayed gritting based surfaces with a very fine micro-structure. The products are characterized by a very pleasant-to-touch matt surface. The products with the ABS surface comply with all the technical requirements for cleanability, chemical resistance, resistance to surface and deep abrasion. Thanks to their qualities, the tiles can find their use both in private and public sector, where the below stated regulation requirements and security rules demand and increased level of slip-resistance R10/B.

In the RAKO HOME and RAKO OBJECT assortment, there are goods with the ABS surface, marked with .



According to Degree 268/2009 Coll., ČSN 72 5191 and DIN 51 130:2014-02, anti-slip floor tiles according to their slip angle for **work floors** should be used.

Slip angle	Identifier	Application
6 – 10°	R9	Entrance areas, interior staircases, toilets in public areas and break rooms, dining rooms, sales and customer rooms
10 – 19°	R10	Changing rooms and washrooms, warm-up and tea kitchens, sales points for packaged goods, toilets and washrooms in schools and kindergartens
19 – 27°	R11	Entrance areas and staircases outside, kitchens for communal catering, vehicle workshop areas
27 – 35°	R12	Washrooms, pump rooms, fire stations
> 35°	R13	Slaughterhouses, refineries, leather production



For floors for **barefoot** walking, according to Degree 268/2009 Coll., CEN/TS 16 165:2012, EN 13451-1, DIN 51 097 and ČSN 72 5191, there are the following slip resistance classes according to the fields of application.

Slip angle	Identifier	Application
≥ 12°	A	mainly dry corridors, changing rooms, dressing rooms, bottoms of pools from 80 up to 135 cm, paddling pools, and dry saunas...
≥ 18°	B	public showers, pool decks, paddling pools, stairs, bottoms of pools up to 80 cm, bottoms of pools with a slope up to 8° and the maximum depth of 135 cm, disinfection tanks, steam saunas...
≥ 24°	C	underwater stairs, inclined pool sides, starting blocks, bottoms of pools with a slope over 8° and the maximum depth of 135 cm, walking areas of chute slides, and ladders...

Tab. 1

Overview of requirements for anti-slip floors				
Regulation	Required value	Country	Field of application	Values and marking RAKO products
Decree 268/2009 Coll. CSN 74 4505 Floors	sliding friction coefficient dry and wet $\mu \geq 0,3$	mandatory in CR	floors of apartment and residential rooms	All floor tiles RAKO $\mu \geq 0,3$
Decree 268/2009 Coll. CSN 74 4505 Floors	sliding friction coefficient dry and wet $\mu \geq 0,5$	mandatory in CR	floors of buildings for public use	floor tiles marked with icons $\mu \geq 0,5$
Decree 268/2009 Coll. CSN 73 4130 Staircases and sliding ramps	for staircases: sliding friction coefficient the walking area staircase $\mu \geq 0,5$, at the front edge staircase degrees to the distance 4 cm from the edge $\mu \geq 0,6$ for dry and wet for sliding ramps: sliding friction coefficient dry and wet $\mu \geq 0,5 + \text{tg } \alpha$	mandatory in CR	staircases and sloping ramps for people with limited mobility	Selected floor tiles of catalogue RAKO HOME OBJECT $\mu \geq 0,6$
Decree 268/2009 Coll. CSN EN 13451-1 Swimming pools ČSN 51 097 DIN 51 097	slip angle $\geq 12^\circ$	mandatory in EU, CR	changing and dressing rooms, dry corridors for barefoot walking, pool bottom without slope from 80 to 135 cm, dry sauna	floor tiles marked with icon A (12°)
	slip angle $\geq 18^\circ$	mandatory in EU, CR	showers, pool decks, paddling pools, stairs, horizontal pool bottoms with 80 cm depth, pool bottom with $<8^\circ$ slope and 135 cm depth, steam sauna	floor tiles marked with icon B (18°)
	slip angle $\geq 24^\circ$	mandatory in EU, CR	starting blocks, water stairs, inclined pool sides, underwater stairs, pool bottom with $>8^\circ$ slope and 135 cm depth, ladder access points, pass-trough area	floor tiles marked with icon C (24°)
Safety regulations ASR A1.5	slip angle from 6 to 10°	non mandatory in CR, mandatory in EU	entrance areas, stairs, canteens, offices, public toilets, exhibition rooms	R9
	slip angle from 10 to 19°		school and kindergartens toilets, dressing rooms, packaged food stores	R10
	slip angle from 19 to 27°		shops for unpackaged goods, outdoor areas, school and kindergarten kitchens, washrooms	R11
	slip angle from 27 to 35°		preparatory and gastronomic cuisine, rooms for repairs and maintenance	R12
	slip angle from 35°		food processing, refineries	R13



Anti-slip characteristics of ceramic tiles RAKO OBJECT according to EN 16165:2021

Serie	Sliding friction coefficient		DIN 51 130		DIN 51 097
	μ (dry)	μ (wet)	R	V (cm³/dm²)	[A, B, C]
Block ^(ABS)	≥ 0,6	≥ 0,5	R10		B
Block lappato	≥ 0,5	≥ 0,4	R9		-
Compila ^(ABS) (DAA..., DAK...)	≥ 0,6	≥ 0,5	R10		B
Compila (DAF...)	≥ 0,6	≥ 0,5	R11		B
Kaamos (DAA..., DAK...)	≥ 0,6	≥ 0,5	R10		A
Kaamos (DAK12..., DDM06...)	≥ 0,6	≥ 0,5	R10		B
Kaamos Industrial	≥ 0,6	≥ 0,5	R10		A
Kaamos Outdoor	≥ 0,7	≥ 0,7	R11		B
TAURUS (surface)					
^(ABS)	≥ 0,6	≥ 0,5	R10		B
Relief SR1	≥ 0,7	≥ 0,6	R11	V4	B
Relief SR2	≥ 0,7	≥ 0,6	R12	V4	B
Relief SR4	≥ 0,7	≥ 0,6	R12	V4	C
Relief SR7	≥ 0,7	≥ 0,6	R11		B
Relief SR20	≥ 0,7	≥ 0,6	R13	V8	C
Relief SRM	≥ 0,7	≥ 0,6	R12		B
Special tiles for visually impaired persons*	≥ 0,7	≥ 0,6	R11		A
ColorTWO a POOL (surface)					
GAK ^(ABS)	≥ 0,6	≥ 0,5	R10		B
GAA ^(ABS)	≥ 0,5	≥ 0,3	-		-
GAF	≥ 0,6	≥ 0,5	R10		B
Relief GRN	≥ 0,6	≥ 0,5	R10		B
Relief GRS	≥ 0,6	≥ 0,5	R10		B
Relief GRH	≥ 0,7	≥ 0,5	-		C
Step tile, step tile flat, signal radius POOL (XP...)	≥ 0,7	≥ 0,6	-		C
Edging tile POOL (XP...)	≥ 0,7	≥ 0,6	-		C
Gutter tile POOL (XP...)	≥ 0,7	≥ 0,6	-		C
Mosaic matt 5 × 5 cm (GDM05...)	≥ 0,5	≥ 0,5	-		-
Mosaic matt 2,5 × 2,5 cm (GDM02...)	≥ 0,5	≥ 0,5	-		-

*Intended only for guiding and warning strips for visually impaired persons

Anti-slip character of floor tiles demands increased cleaning requirements

For floors with high requirements for slip resistance, the ASR A1.5 regulation recommends appropriate embossment, where, for example in food industry or industrial kitchens, the embossed surface of tiles must be able to accommodate a certain amount of fat or other substances into its cavities. Depending on the type and height of the embossment, a so-called discharge volume in cm³ per 1 dm² is defined in accordance with DIN 51 130, and designated by the V letter and the corresponding numerical value (for example: V4), see Table 2. For measured anti-slip values according to the pendulum or mobile tribometr test method (DCOF) for North America, see Table 3.

Tab.2		Tab.3			
Min. discharge volume in cm³/dm²	Identifier	Group of goods	Pendulum (AS 4586)	Pendulum (CEN/TS 16165:2012)	DCOF (ANSI A137.1)
> 4	V4	Outdoor (Kaamos, Piazzetta, Quarzit, Rebel)	class 3	> 36	> 0,7
> 6	V6				
> 8	V8				
> 10	V10				

Anti-slip characteristics of ceramic tiles RAKO HOME according to EN 16165:2021

Antislip characteristics Serie	Sliding friction coefficient		DIN 51 130	DIN 51 097
	μ (dry)	μ (wet)	R	[A, B, C]
Alba (DAR...)	≥ 0,6	≥ 0,5	R10	A
Alba (DDM06...)	≥ 0,6	≥ 0,5	R10	B
Alba (DAP..., DDPSE...)	≥ 0,6	≥ 0,5	R9	-
Base (DAK...)	≥ 0,5	≥ 0,3	R9	A
Base (DDN06...)	≥ 0,6	≥ 0,5	R10	A
Betonico ^(ABS)	≥ 0,6	≥ 0,5	R10	B
Betonico (DAF...)	≥ 0,6	≥ 0,5	R11	B
Betonico Outdoor	≥ 0,7	≥ 0,7	R11	B
Blend	≥ 0,5	≥ 0,5	R9	A
Blend (DDM...)	≥ 0,5	≥ 0,5	R10	A
Board (DAK...)	≥ 0,6	≥ 0,5	R9	A
Board (DDM06..., DDPSE...)	≥ 0,6	≥ 0,5	R10	A
Bricola ^(ABS)	≥ 0,6	≥ 0,5	R10	B
Bricola Outdoor	≥ 0,7	≥ 0,7	R11	B
Castone ^(ABS)	≥ 0,6	≥ 0,5	R10	B
Castone Outdoor	≥ 0,7	≥ 0,7	R11	B
Cava (DAK...)	≥ 0,5	≥ 0,5	R9	A
Cava (DAL..., DDL06...)	≥ 0,5	≥ 0,3	-	-
Cava (DDM06...)	≥ 0,5	≥ 0,5	R10	B
Cemento (DAK...)	≥ 0,6	≥ 0,5	R9	-
Cemento (DAR..., DDM06...)	≥ 0,6	≥ 0,5	R10	B
Cemento (DDPSE...)	≥ 0,6	≥ 0,5	R10	A
Cemento (DAG...)	≥ 0,7	≥ 0,6	R11	C
Como (DAR..., DDP...)	≥ 0,6	≥ 0,5	R9	A
Como (DDM05...)	≥ 0,6	≥ 0,5	R10	A
Compila ^(ABS) (DAA..., DAK...)	≥ 0,6	≥ 0,5	R10	B
Compila (DAF...)	≥ 0,7	≥ 0,6	R11	B
Concept	≥ 0,6	≥ 0,5	R9	-
Deco	≥ 0,6	≥ 0,5	R9	-
Era	≥ 0,6	≥ 0,5	R9	A
Era (DDM05...)	≥ 0,7	≥ 0,6	R10	B
Extra ^(ABS)	≥ 0,6	≥ 0,5	R10	B
Faro	≥ 0,6	≥ 0,5	R9	A
Faro (DDM06...)	≥ 0,6	≥ 0,5	R10	B
Fashion	≥ 0,6	≥ 0,5	R9	A
Fashion (DDMBG...)	≥ 0,6	≥ 0,5	R10	A
Flash (DAK...)	≥ 0,5	≥ 0,5	R9	A
Flash (DDM06...)	≥ 0,5	≥ 0,5	R10	B
Form (DAA...)	≥ 0,6	≥ 0,5	R9	A
Form (DDM05..., DDR05...)	≥ 0,6	≥ 0,5	R10	A
Garda	≥ 0,6	≥ 0,5	R9	A
Levante (DAK...)	≥ 0,6	≥ 0,5	R9	A
Levante (DDM06...)	≥ 0,6	≥ 0,5	R10	B
Limestone (DAK...)	≥ 0,5	≥ 0,5	R9	A
Limestone (DAR..., DDM06...)	≥ 0,6	≥ 0,5	R10	A
Limestone (DAL...)	≥ 0,5	≥ 0,3	-	-
Linka ^(ABS)	≥ 0,6	≥ 0,5	R10	B
Onyx (DAK...)	≥ 0,5	≥ 0,5	R9	A
Onyx (DDM06...)	≥ 0,5	≥ 0,5	R10	B
Onyx (DAL..., DDL06...)	≥ 0,5	≥ 0,3	-	-
Piazzetta ^(ABS)	≥ 0,6	≥ 0,5	R10	B
Piazzetta Outdoor	≥ 0,7	≥ 0,7	R11	B
Plywood ^(ABS)	≥ 0,6	≥ 0,5	R10	B
Porfido ^(ABS)	≥ 0,6	≥ 0,5	R10	B
Quarzit (DAK...)	≥ 0,5	≥ 0,5	R9	A
Quarzit (DAR..., DDM06...)	≥ 0,6	≥ 0,5	R10	B
Quarzit Outdoor	≥ 0,7	≥ 0,7	R11	B
Random (DAK...)	≥ 0,6	≥ 0,5	R9	A
Random (DDM06...)	≥ 0,6	≥ 0,5	R10	A
Rebel (DAK..., DAA...)	≥ 0,6	≥ 0,5	R9	A
Rebel (DDM06..., DAK12...)	≥ 0,6	≥ 0,5	R10	B
Rebel Outdoor	≥ 0,7	≥ 0,7	R11	B
Saloon (DAK...)	≥ 0,6	≥ 0,5	R9	A
Saloon (DDM06...)	≥ 0,6	≥ 0,5	R10	B
Siena	≥ 0,6	≥ 0,4	R9	-
Siena (DDP44...)	≥ 0,6	≥ 0,5	R9	A
Stones (DAK...)	≥ 0,6	≥ 0,5	R10	A
Stones (DAR..., DD...)	≥ 0,6	≥ 0,5	R10	B
Stones (DAP...)	≥ 0,6	≥ 0,5	R9	-
Stones (DAG...)	≥ 0,7	≥ 0,6	R11	C
Vals ^(ABS)	≥ 0,6	≥ 0,5	R10	B
Vals Outdoor	≥ 0,7	≥ 0,7	R11	B
Via	≥ 0,6	≥ 0,5	R9	A
Via (DDM05...)	≥ 0,6	≥ 0,5	R10	B

Requirements on slip resistance of floors are defined by national public notices and standards. The floors must be level with a surface of the specified degree of slip resistance, which must be maintained regularly. For floors used by the public, PN 268/2009 and the ČSN 74 4505 floor standard specify a basic minimum coefficient of friction 0.5. For floors which are not protected against rain

(e.g. on terraces, balconies and loggias), the anti-slip criterion must be met even when the surface is wet. German safety regulation ASR A1.5 can serve the as suitable guidelines for more detailed selection of slip resistance parameters for specific conditions for workplace floors and floors in premises intended for work with the danger of slipping.

0	General work rooms and areas*		9.3	Kitchens catering for hospitals, clinics	R12	15	Leather production, textiles		26.2	Rooms for hose maintenance equipment	R12
0.1	Entrance areas, indoors**)	R9	9.4	Large kitchens catering for industrial and university canteens, and contract catering	R12	15.1	Wet areas in tanneries	R13	27	Inhalation and air passage treatment facilities	
0.2	Entrance areas, outdoors	R11 or R10 V4				15.2	Rooms with fleshing machines	R13 V10	27.1	Preparation room	R10
0.3	Stairs, indoors***)	R9	9.5	Food preparation kitchens (fast food kitchens, snack bars)	R12	15.3	Areas where leather scraps accumulate	R13 V10	27.2	Conditioning room	R10
0.4	Outdoor stairs	R11 or R10 V4	9.6	Kitchens for heating up frozen meals	R10	15.4	Rooms for making leather impermeable by means of grease	R12	27.3	Exercise room	R11
0.5	Sloping indoor ramps (from 3% inclination, e.g., for wheelchairs)	one degree higher then surroundings	9.7	Coffee and tea kitchens, hotel garni kitchens and ward kitchens	R10	15.5	Dye mills for textiles	R11	27.4	Sluice	R10
			9.8	Washing-up rooms		16	Paint shops		27.5	Target premises	R11
0.6	Sanitary premises		9.8.1	Washing-up rooms for 9.1, 9.4, 9.5	R12 V4	16.1	Wet grinding workshops	R12 V10	27.6	Warming room	R11
0.6.1	Toilets	R9	9.8.2	Washing-up rooms for 9.2	R11	16.2	Powder paint shops	R11	27.7	Dispatch room	R9
0.6.2	Washrooms and change rooms	R10	9.8.3	Washing-up rooms for 9.3	R12	16.3	Spray paint shops	R10	28	Schools and kindergartens	
0.7	Relaxation rooms and canteens	R9	9.9	Dining rooms, guest rooms, canteens including serving counters	R9	17	Ceramics industry		28.1	Entrances, corridors, break halls	R9
0.8	First aid rooms	R9	9.10	Bar area, counter area	R10	17.1	Wet grinding mills (processing of ceramic raw materials)	R11	28.2	Classrooms	R9
1	Manufacture of margarine, edible fats and oils		10	Cold stores, deep freeze stores		17.2	Mixers; handling of materials like tar, pitch, graphite and synthetic resins	R11 V6	28.3	Staircases	R9
1.1	Melting of fat	R13 V6	10.1	for unpacked goods	R12	17.3	Presses (shaping); handling of materials like tar, pitch, graphite and synthetic resins	R11 V6	28.4	Toilets, washrooms	R10
1.2	Cooking oil refinery	R13 V4	10.2	for packed goods	R11	17.4	Moulding areas	R12	28.5	Teaching kitchens in schools (see also 9.2, 9.6 or 9.7)	R10
1.3	Margarine production and packaging	R12	11	Sales outlets, shops		17.5	Glazing areas	R12	28.6	Kitchens in kindergartens (see also 9)	R10
1.4	Cooking fat production and packing, oil bottling	R12	11.1	Reception of goods, meat	R11	18	Glass and stone processing		28.7	Wood processing workshops	R10
2	Milk processing, cheese production		11.1.1	For unpacked goods (e.g. loose in shipping boxes)	R10	18.1	Stone cutting, stone grinding	R11	28.8	Technical sections of workshops	R10
2.1	Fresh milk processing and butter production	R12	11.1.2	For packed goods	R11	18.2	Glass shaping of hollow glass ware, container ware, glass for building purposes	R11	28.9	School courtyards	R11 or R10 V4
2.2	Cheese production, storage and packaging	R11	11.2	Reception of goods, fish	R11	18.3	Grinding areas for hollow glass ware, flat glass	R11	29	Financial institutions	
2.3	Icecream manufacturing	R12	11.3	Serving counters for meat and sausage		18.4	Insulating glass manufacture; handling of drying agents	R11 V6	29.1	Counter areas	R9
3	Chocolate and confectionery production		11.3.1	For unpacked goods	R11	18.5	Packaging, shipping of flat glass; handling of anti-adhesive agents	R11 V6	30	Plant traffic routes in outdoor areas	
3.1	Sugar processing	R12	11.3.2	For packed goods	R10	18.6	Etching and acid polishing facilities for glass	R11	30.1	Footpaths	R11 or R10 V4
3.2	Cocoa production	R12	11.4	Service point for bread, bakery products, unpackaged goods.	R10	19	Cast concrete factories		30.2	Loading platforms	
3.3	Production of raw mixtures	R11	11.5	Serving counters for dairy products and delicatessen, unpacked goods	R10	19.1	Concrete washing areas	R11	30.2.1	Covered	R11 or R10 V4
3.4	Fabrication of chocolate bars and shells and filled chocolates	R11	11.6	Serving counters for fish		20	Storage areas		30.2.2	Not covered	R12 or R11 V4
4	Production of bread, cakes and pastries		11.6.1	For unpacked goods	R12	20.1	Storage areas for oils and fats (which are intended for partial disposal, e.g., in workshops)	R12 V6	30.3	Sloping ramps (from 3% inclination e.g. for wheel-chairs, loading platforms)	R12 or R11 V4
	(bakeries, cake shops, production of long-life bakery products)		11.6.2	For packed goods	R11	20.2	Areas for packed food	R10	30.4	Tank-up areas	
4.1	Dough preparation	R11	11.7	Serving counters, except for nos. 11.3 to 11.6	R9	20.3	Outdoor storage areas	R11 or R10 V4	30.4.1	Tank-up areas, covered	R11
4.2	Rooms in which predominantly fats or liquid mixtures are processed	R12	11.8	Meat preparation rooms		21	Chemical and thermal treatment of iron and metal		30.4.2	Tank-up areas, not covered	R12
4.3	Washing-up rooms	R12 V4	11.8.1	For meat preparation, except for no. 5	R12 V8	21.1	Pickling plants	R12	31	Parking facilities	
5	Slaughtering, meat processing		11.8.2	For meat processing, except for no. 5	R11	21.2	Hardening shops	R12	31.1	Car parks and u/g garages not affected by weather *****)	R10
5.1	Slaughter-house	R13 V10	11.9	Florists shops	R11	21.3	Laboratory rooms	R11	31.2	Car parks and u/g garages affected by weather	R11 or R10 V4
5.2	Tripe processing room	R13 V10	11.10	Points of sales with ovens		22	Metal processing, metal workshops		31.3	Outdoor parking lots	R11 or R10 V4
5.3	Meat sectioning	R13 V8	11.10.1	For the production of bread, cakes and pastries	R11	22.1	Galvanizing shops	R12	32	Spa	
5.4	Sausage kitchen	R13 V8	11.10.2	For the warming up of prefabricated bread, cakes and pastries	R10	22.2	Grey cast iron processing	R11 V4	32.1	Individual and shared changing rooms	R10
5.5	Boiled sausage unit	R13 V8	11.11	Sales areas with stationary chip pans or grills	R12 V4	22.3	Mechanical processing areas (turnery, milling shop), punching room, pressroom, drawing shop (pipes, wires)	R11	32.2	Saunas and relaxation areas	R10
5.6	Raw sausage unit	R13 V6	11.12	Shops, customer rooms	R9	22.4	Mechanical processing areas with increased oil and lubricant load	R11 V4	32.3	Showers and shower areas	R10
5.7	Sausage drying room	R12	11.13	Preparation areas for food for self-service shops	R10	22.5	Parts cleaning areas, exhaust steam areas	R12	32.4	Pool surroundings	R10
5.8	Gut store	R12	11.14	Cash register areas, packing areas	R9	23	Vehicle repair workshops				
5.9	Salting and curing rooms, smoking establishments	R12	11.15	Outdoor sales areas	R11 or R10 V4	23.1	Repair and servicing bays	R11			
5.10	Poultry processing	R12 V6	12	Health service rooms		23.2	Working and inspection pits	R12 V4			
5.11	Cold cuts and packaging unit	R12	12.1	Disinfection rooms (wet)	R11	23.3	Car washing halls, washing areas	R11 V4			
5.12	Workshop with sales area	R12 V8 *****)	12.2	Pre-cleaning areas of sterilization	R10	24	Aircraft repair workshops				
6	Fish processing, production of delicatessen		12.3	Faeces disposal rooms, discharge rooms, unclean nursing work rooms	R10	24.1	Aircraft hangars	R11			
6.1	Fish processing	R13 V10	12.4	Pathological facilities	R10	24.2	Repair hangars	R12			
6.2	Production of delicatessen	R13 V6	12.5	Rooms for medical baths, hydrotherapy, fango preparation	R11	24.3	Washing halls	R11 V4			
6.3	Manufacture of mayonnaise	R13 V4	12.6	Washrooms of operating theatres, plastering rooms	R10	25	Sewage treatment plants				
7	Processing of vegetables		12.7	Sanitary rooms, ward bathrooms	R10	25.1	Pump rooms	R12			
7.1	Production of sauerkraut	R13 V6	12.8	Rooms for medical diagnosis and therapy, massage rooms	R9	25.2	Rooms for sludge draining facilities	R12			
7.2	Vegetable tinning	R13 V6	12.9	Operating theatres	R9	25.3	Rooms for screening equipment	R12			
7.3	Sterilizing rooms	R11	12.10	Wards with hospital rooms and corridors	R9	25.4	Stands of workplaces, scaffolds and maintenance platforms	R12			
7.4	Rooms in which vegetables are prepared for processing	R12 V4	12.11	Medical practices, day clinics	R9	26	Fire brigade buildings				
8	Wet areas in food and beverage production		12.12	Pharmacies	R9	26.1	Vehicle parking places	R12			
	(if not specifically mentioned)		12.13	Laboratories	R9						
8.1	Storage cellars	R10	12.14	Hairdressing salons	R9						
8.2	Beverage bottling, fruit juice production	R11	13	Laundry							
9	Catering establishments		13.1	Rooms with continuous-flow washing machines or with spin-drier	R9						
9.1	Kitchens in the catering trade (restaurant kitchens, hotel kitchens)	R12	13.2	Rooms with washing machines at which the clothes are taken out dripping wet	R11						
9.2	Kitchens for catering purposes at special-purpose homes, schools, kindergartens, and sanatoria	R11	13.3	Ironing rooms	R9						
			14	Fodder concentrate production							
			14.1	Dried fodder production	R11						
			14.2	Fodder concentrate production using fat and water	R11 V4						

*) For floors in wet areas walked on barefoot, see the DGUV information "Floor coverings in wet barefoot areas" (ASR A1.5).

**) Entrance areas according to number 0.1 are all areas with direct access from outside and in which moisture from outside can be brought.

***) Stairs according to number 0.3 are those possibly not exposed to moisture brought in from outside.

****) If the same floor covering was laid in all areas, the displacement space can be lowered down to V4 after a risk analysis (taking into consideration the cleaning method, the working processes and the quantity of slippery substances on the floor).

*****) The pedestrian areas which are not subject to a risk of slipping because of weather influences such as driving rain or moisture brought in.

3.7 BREAKING RESISTANCE

Mechanical resistance of ceramic tiles to breakage is determined by several methods of measurement: modulus of rupture, breaking strength and design load capacity

Modulus of rupture according to EN ISO 10545-4 expresses the tile ability to resist without destruction a mechanical load. The tiles of smaller sizes and larger thickness are more resistant than thinner tiles of larger sizes. Products with a thickness of 8–10 mm are suitable for general use in residential areas or where tyres are filled with air (e.g. car showrooms, garages). Floors subjected to higher mechanical stresses (shops, warehouses, industry), e.g. with Vulkollan or polyamide wheels, are then classified in load group 3–5, see Table 1, Working procedures for high-load pavements. Taurus INDUSTRIAL in 14 mm thickness or Kaamos INDUSTRIAL in 15 mm thickness are recommend here. Ceramic products are not suitable for floors that are traversed with steel wheels without rubber, see Table 4, Mean loads under different transport vehicle wheels. In addition to the stationary load, the wheel material used and the dynamic surface load must also be taken into account.

Breaking load is force necessary to cause the test specimen to break, as read to pressure gauge (EN ISO 10545-4). Threshold value to fracture the tile is expressed by breaking strength – see Table 2.

Tiles to be layed by dry method (on support system) have to be selected with respect to following threshold values to secure safe construction according to ČSN EN 1991-1-1 Construction loading and ČSN 73 2030 Loading tests of building constructions. **Design load capacity** is based on laboratory measurement of bearing capacity of tiles loaded on several spots. For the size of tile 60 × 60 cm in thickness of 2 cm bearing (loading) capacity is max. 5 000 N (± 500 kg). For laying into gravel the values of design load capacity for the size 60 × 60 cm in thickness of 2 cm as safe values can be considered.

Modulus of rupture (N/mm², MPa) according to EN ISO 10545-4

$$R = \frac{3 \times F \times L}{2 \times b \times h^2}$$

Breaking strength (N) according to EN ISO 10545-4

$$S = \frac{F \times L}{b}$$

F = breaking load in N, L = distance between edges in mm, b = width in mm, h = thickness in mm, R = modulus of rupture N/mm²

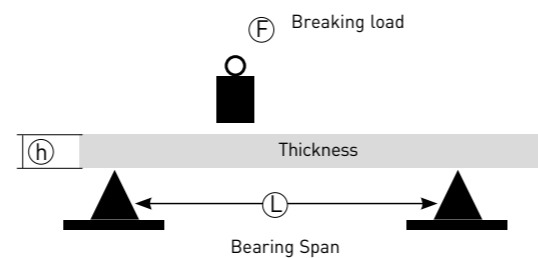
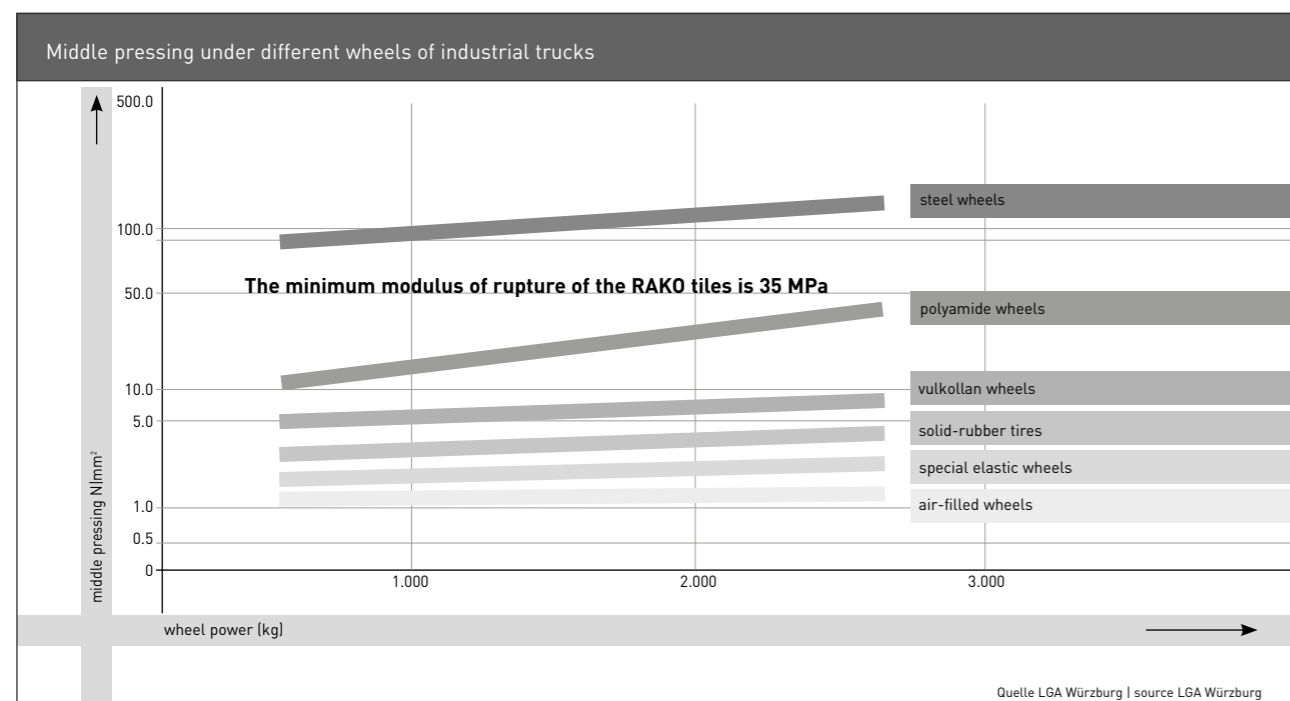

Fig. 2



Tab. 4

Work procedures for tiles with a high amount of traffic (recommending guideline according to German ZDB Standard)		
Traffic load group	Traffic load group	Breaking strength after breaking the tile (N)
1	flats, bathrooms	< 1 500
2	shops, offices, exhibitions	1 500–3 000
3	shops, industry, warehouses	3 000–5 000
4	industry (motion of trucks with volcano or polyamide)	5 000–8 000
5	industry (motion of trucks with polyamide or metal wheels)	> 8 000

Tab. 5

Group of products with catalogue numbers	Thickness [mm]	Breaking strength [N] EN ISO 10545-4	Design load capacity [N] (±kg) ČSN EN 1991-1-1 ČSN 732030
Dxxxxxxx, Gxxxxxxx, Txxxxxxx	< 7,5	700	
Gxxxxxxx, Dxxxxxxx	≥ 7,5	1 300	
Txxxxxxx a Dxxxxxxx (quadratisches Format square format format carré) außer Großformate except big formats sauf pour les grands formats*	≥ 8	1 500	
Txx3Vxxx, Txx2Zxxx	≥ 14	5 000	
TxxSExxx, TxxSAxxx, DxxSExxx, Txx63xxx, Txx61xxx, Dxx63xxx	≥ 10	2 000	
Dxx65xxx	≥ 15	6 000	
Dxx66xxx	≥ 20	11 000	5 000 (± 500)

*Big formats of ceramic tiles with length of one size ≥ 80 cm.

3.8 THERMAL PROPERTIES

Thanks to their convenient thermal properties (conductivity and heat accumulation), all types of LASSELSBERGER, s.r.o. tiles are ideal floor coverings on underfloor heating.

Comparison of thermal conductivity of floor coverings:

Material	Coefficient of heat conductivity λ (W/m·K)	Thermal emission b (λ·ρ·c)
Ceramics	1,0	1,8
Cement screed/concrete	1,3	2,6
Anhydrite	1,8	3,8
PVC, vinyl	0,2	0,3
OSB boards	0,1	0,3

ρ – volume weight (kg/m³)

c – specific thermal capacity (J/kg·K)

The coefficient of thermal expansion of wall tiles and floor tiles is very low. At a distance of 6 m, and at a temperature difference of 50° C, the ceramic material is expanded by 2.4 mm. However concrete, for example, changes its length to about twice this value. Therefore, dilatation joints are performed, which are able to absorb such stresses in the base. Comparison of coefficients of linear thermal expansion for different materials:

Material	Coefficient of linear thermal expansion α (10 ⁻⁶ ·K ⁻¹)
Ceramics	4–8
Cement screed/concrete	10–12
Steel	12–13
Aluminium	22–28
PVC, vinyl	50–66

3.9 CHEMICAL PROPERTIES



RESISTANCE TO CHEMICALS, EN ISO 10545-13

Chemical resistance is assessed according to EN ISO 10545-13. Ceramic tiles are exposed to test solutions and, depending on inspection results after a set period, they are divided into the following classes. LASSELSBERGER, s.r.o. tiles are resistant to household chemicals and agents for water treatment in swimming pools according to EN ISO 10545-13. **Selected tiles with increased chemical resistance, classified in Class A, designated with an icon  are resistant to acids and alkali according to EN ISO 10545-13. Other LASSELSBERGER, s.r.o. tiles are classified as follows: min. B.**

Aqueous test solutions

- Household chemicals: ammonium chloride solution 100 g/l;
- salts for water treatment in swimming pools: sodium hypochlorite solution 20 g/l

Classes according to EN 14 411:

- A/B/C*

Acids and alkalis

- Low concentration (L)
 - a) hydrochloric acid solution 3%
 - b) citric acid solution 100 g/l
 - c) potassium hydroxide solution 30 g/l
- High concentration (H)
 - a) hydrochloric acid solution 18%
 - b) lactic acid solution 5%
 - c) potassium hydroxide solution 100 g/l

Household chemical resistance classes according to EN ISO 10545-13 (minimum of class B required):

- A/B/C*

* Class A shows the highest resistance to chemicals, which decreases more and more towards C.

Stain resistance, EN ISO 10545-14

Tile surfaces are exposed to test solutions of stain-forming substances for a set period, cleaned in the specified manner, and changes are visually assessed. Following the results, the tiles are classified into five classes.

Stain-forming substances used for testing

- Stain forming substances, leaving traces; green stain forming substances in oil; red stain forming substances in oil
- Chemical stain forming substances; iodine, 13 g/l in alcohol
- Stain forming substances, forming a film; olive oil

Cleaning

- Cleaning agent: hot water (+55 °C); weak cleaning agent (pH 6,5-7,5); strong cleaning agent agent (pH 9-10)
- Solvent: hydrochloric acid solution 3%; potassium hydroxide solution 200 g/l; acetone
- Unsuitable chemical substances: ceramic tiles are not hydrofluoric acid resistant

Classes: 5/4/3/2/1*

* Class 5 shows the highest stain resistance, which decreases more and more towards 1.

Lead and cadmium delivery, EN ISO 10545-15

The quantity of released lead and cadmium is determined on the basis of extraction of glazed tile faces with the acetic acid solution.

3.10 ELECTRICAL PROPERTIES

Antistatic flooring is required for floors of operating theatres, laboratories, production of medical and pharmaceutical products, explosive substances and microelectronics. Ceramic tiles belong among electrical insulators, therefore, electric charge is discharged using conductive joints between small or mosaic tiles.

3.11 HYGIENIC PROPERTIES

Ceramic products LASSELSBERGER, s.r.o. are regularly tested for release of lead (Pb) and cadmium (Cd) from glazes according to EN ISO 10545-15. The performed analyses prove the ceramic tiles by LASSELSBERGER, s.r.o., are harmless for human health, see the statement of properties on www.rako.eu Selected TAURUS, ColorTWO and POOL products have attestations of sanitary harmlessness in contact with food and drinking water.

Ceramic wall and floor tiles including shaped pieces, rounded mouldings with corrugation ColorTWO or TAURUS and Taurus GRANIT base moulding for food processing areas with radius R 44 of the rounding are easy to maintain, thus allowing for compliance with the strict hygienic requirements for food processing plants and healthcare facilities. They are suitable for all types of applications requiring surfaces free of pathogenic germs, moulds, dust, and other pollutants. Suitable application of ceramic tiles on floors and walls can also improve the home microclimate, e.g. reduce occurrence of dust, pollen and mites.

3.12 OPTICAL PROPERTIES

Optical characteristics of tiling elements – LRV

The capacity of ceramic tiling elements to reflect or absorb light is a consideration for certain applications using LRV coefficient (Light reflectance value). We also use a contrast of light and dark areas on the floor to improve orientation, so called Light contrast. Requirements for safe orientation in buildings are specified by the standard ÖNORM B 1600:2012 and DIN 18040. The light contrast (K) is determined by DIN 32 984 which requires a minimal value 0.4.

Light contrast calculation:

$$K = \frac{LRV1 - LRV2}{LRV1 + LRV2}$$

(note: K= light contrast; LRV1= higher value of light reflection, when LRV ≥ 50; LRV2= lower value)

LRV values are only informative and can change in relation to the hue of individual batches.

LRV values for selected tiling elements are measured using a spectrophotometer according to CIE 1931:

RAKO HOME		
Serie	LRV	
Betonico	DAxxx790	61
Betonico	DAxxx791	22
Betonico	DAxxx792	15
Betonico	DAxxx793	45
Betonico	DAxxx794	38
Extra	DARxx720	55
Extra	DARxx721	26
Extra	DARxx722	58
Extra	DARxx723	41
Extra	DARxx724	20
Extra	DARxx725	9
Rebel	DAxxx740	54
Rebel	DAxxx741	43
Rebel	DAxxx742	22
Rebel	DAxxx743	52

RAKO OBJECT	Light reflectance values ColorONE, ColorTWO, POOL (matt)		Light reflectance values ColorONE, ColorTWO, POOL (glossy)	
RAL 0304060	WAAxx373 GAAxx459	15	WAAxx363 GAAxx359	17
RAL 0506080	WAAxx460 GAAxx460	34	WAAxx450	29
RAL 0607050	WAAxx282 GAAxx150 GAAxx750	48	WAAxx272	48
RAL 0858070	WAAxx222 GAAxx142 GAAxx742	57	WAAxx201	60
RAL 0908040	WAAxx221 GAAxx124	61	WAAxx200	64
RAL 0958070	WAAxx464 GAAxx464	60	WAAxx454	58
RAL 1208050	WAAxx465 GAAxx465	54	WAAxx455	56
RAL 1306050	WAAxx466 GAAxx466	31	WAAxx456	29
RAL 1907025	WAAxx467 GAAxx467 GAAxx767	40	WAAxx457	39
RAL 2408015	WAAxx540 GAAxx003 GAAxx703	59	WAAxx550	61
RAL 2606025	WAAxx541 GAAxx127	28	WAAxx551	29
RAL 2902035	WAAxx545 GAAxx005, GAAxx555 GAAxx755	6	WAAxx555	6
RAL 0001500	WAAxx732 GAAxx048	5	WAAxx779 GAAxx548	5
RAL 0004000	WAAxx765 GAAxx248	10	WAAxx755	10
RAL 0805005	WAAxx111 GAAxx111	18	WAAxx011	21
RAL 0607005	WAAxx110, WAAxx210 GAAxx110	49	WAAxx010	49
RAL 0008500	WAAxx112 GAAxx112	70	WAAxx012	68
WHITE	WAAxx104 GAAxx023	79	WAAxx000 GAAxx052	90
RAL 0709010	WAAxx107 GAAxx107	78	WAAxx007	78
RAL 0508010	WAAxx108 GAAxx108	57	WAAxx008	63
RAL 0607020	WAAxx311 GAAxx311	39	WAAxx301	37
RAL 0607010	WAAxx312 GAAxx312	33	WAAxx302	32
RAL 0805010	WAAxx313 GAAxx313	18	WAAxx303	19
RAL 0502010	WAAxx681 GAAxx671	6	WAAxx671	7

Light reflectance values, unglazed floor tiles Taurus COLOR		Light reflectance values, unglazed floor tiles Taurus GRANIT		Light reflectance values, unglazed floor tiles	
TAAxx019	8	TAAxx069	11	BLOCK	
TAAxx007	16	TAAxx065	18	DAxxx780	37
TAAxx006	26	TAAxx076	31	DAxxx781	27
TAAxx003	35	TAAxx078	36	DAxxx782	18
TAAxx011	65	TAAxx060	66	DAxxx783	11
TAAxx010	51	TAAxx062	51	DAxxx784	39
TAAxx025	19	TAAxx061	40		
		TAAxx068	28	KAAMOS	
		TAAxx074	33	DAxxx585	48
		TAAxx082	17	DAxxx586	43
		TAAxx080	27	DAxxx587	28
		TAAxx075	31	DAxxx588	14
				DAxxx589	25

Optical characteristic

RAL Design 0304060 red RAL Classic 3031 NCS 2070-Y90R Pantone 1807		WAA++373 WAA++363 GAA++459 GAA0K359	RAL Design 0502010 dark brown RAL Classic 8019 NCS 8010-Y90R --		WAA++681 WAA++671 GAA1K671
RAL Design 0506080 orange RAL Classic 2004 NCS 0580-Y60R Pantone Orange 021		WAA++460 WAA++450 GAA1K460	RAL Design 0805010 grey-beige RAL Classic 7006 NCS 5005-Y20R Pantone 450		WAA++313 WAA++303 GAA++313
RAL Design 0607050 light orange RAL Classic 1034 NCS 1050-Y40R Pantone 143		WAA++282 WAA++272 GAA++150	RAL Design 0607010 beige-grey RAL Classic 1019 NCS 3010-Y20R --		WAA++312 WAA++302 GAA++312
RAL Design 0858070 dark yellow RAL Classic 1018 NCS 1070-Y Pantone 107		WAA++222 WAA++201 GAA++142	RAL Design 0607020 dark beige -- NCS 2010-Y40R Pantone 466		WAA++311 WAA++301 GAA1K311
RAL Design 0908040 yellow -- NCS 1030-Y Pantone 460		WAA++221 WAA++200 GAA1K124	RAL Design 0508010 beige -- NCS 1005-Y50R Pantone 4755		WAA++108 WAA++008 GAA++108
RAL Design 0958070 yellow-green RAL Classic 1016 NCS 1070-G90Y Pantone 3965		WAA++464 WAA++454 GAA1K464	RAL Design 0709010 light beige RAL Classic 9001 NCS 0603-Y30R --		WAA++107 WAA++007 GAA++107
RAL Design 1208050 light green -- NCS 0550-G30Y Pantone 366		WAA++465 WAA++455 GAA1K465	WHITE white RAL Classic 9003 NCS 0500-N --		WAA++104 WAA++000 GAA++023 GAA0K052
RAL Design 1306050 green RAL Classic 6018 NCS 2060-G30Y Pantone 369		WAA++466 WAA++456 GAA++466	RAL Design 0008500 light grey RAL Classic 7047 NCS 2000-N Pantone 5315		WAA++112 WAA++012 GAA++112
RAL Design 1907025 turquoise RAL Classic 6027 NCS 2030-B50G Pantone 564		WAA++467 WAA++457 GAA++467	RAL Design 0607005 grey RAL Classic 7044 NCS 4005-Y50R --		WAA++110 WAA++010 GAA++110
RAL Design 2408015 light blue -- NCS 1020-R90B Pantone 277		WAA++540 WAA++550 GAA++003	RAL Design 0805005 dark grey RAL Classic 7039 NCS 5502-Y Pantone Warm grey 10		WAA++111 WAA++011 GAA1K111
RAL Design 2606025 blue RAL Classic 5024 NCS 2040-R80B Pantone 659		WAA++541 WAA++551 GAA1K127	RAL Design 0004000 anthracite grey RAL Classic 7043 NCS 7000-N Pantone 426		WAA++765 WAA++755 GAA++248
RAL Design 2902035 dark blue RAL Classic 5022 NCS 4550-R70B Pantone Blue 072		WAA++545 WAA++555 GAA++++5	RAL Design 0001500 black RAL Classic 7021 NCS 9000-N Pantone Black 3 2x		WAA++732 WAA++779 GAA++048 GAA0K548

* The colours codes and the shades shown are for orientation only.

3.13 ADHESION OF CERAMIC TILES

RAKO ceramic tiles are tested for adhesion towards cement-based adhesives pursuant to EN 14 411. The performed analyses confirm the following values:

- $\geq 1.0 \text{ N/mm}^2$ for product group BIa with the water absorption $E \leq 0.5 \%$ and cementitious adhesives, type C2
- $\geq 0.5 \text{ N/mm}^2$ for product group BIII with the water absorption $E > 10 \%$, and cementitious adhesives, type C1
- $\geq 1.0 \text{ N/mm}^2$ for product group BIII with the water absorption $E > 10 \%$, and dispersion adhesives
- $\geq 2.0 \text{ N/mm}^2$ for product group BIII with the water absorption $E > 10 \%$, and reaction resin adhesives

3.14 REACTION TO FIRE















RAKO ceramic tiles are fire resistant. They are classified according to EN 14 411:

- Class A1-A1_{FL} for a BIa group of products (Annex G) with water absorption $\leq 0.5 \%$
- Class A1 for a BIII group of products (Annex L) with water absorption $> 10 \%$



STO No. 030 - 059824
- Catalogue number: XXXXXXXX
ceramic special pieces

Technical characteristics	Norm	Standard requirements EN14411 (max. value)	Parameters LB (max.)	
Sizes	ISO 10545-2	Length and width	$\pm 2,0 \%$	$\pm 2,0 \%$
		Thickness	$\pm 10 \%$	$\pm 10 \%$
Water absorption	ISO 10545-3	$E < 0,5\%$	$E < 0,5\%$	
Surface quality	ISO 10545-2	Min. 95 % of the tiles without visible defects	Min. 95 % of the tiles without visible defects	
Modulus of rupture	ISO 10545-4	Thickness $\geq 7,5 \text{ mm}$ min. 28 N/mm ²	$\geq 7,5 \text{ mm}$ min. 28 N/mm ²	
Breaking strength	ISO 10545-4	Thickness $\geq 7,5 \text{ mm}$ min. 1300 N	$\geq 7,5 \text{ mm}$ min. 1300 N	
Thermal shock resistance	ISO 10545-9	Not required	Resistant	
Frost resistance	ISO 10545-12	Required	Fully frost resistant	
Crazing resistance for glazed tiles	ISO 10545-11	Required	Resistant	
Slipperiness - coefficient of friction	EN 16165:2021 DIN 51130 DIN 51097 ČSN 725191	Manufacturer to state value and test method used	Selected types C	
Deep abrasion resistance	ISO 10545-6	Not required	Max. 275 mm ²	
Surface hardness according to Mohs scale	ČSN EN 101	Manufacturer to state classification	Min. cl. 5	
Coefficient of linear thermal expansion (20-100 °C)	ISO 10545-8	Not required	Max. $9 \cdot 10^{-6} \text{ } ^\circ\text{C}$	
Resistance to various chemicals used in household	ISO 10545-13	Min. B	Min. A	
Resistance to low concentrations of acids and alkalis	ISO 10545-13	Manufacturer to state classification	Min. cl. B	
Resistance to high concentrations of acids and alkalis	ISO 10545-13	Not required	Min. cl. B	
Resistance to staining	ISO 10545-14	Min. cl. 3	Min. cl. 3	
Release of dangerous substances	ISO 10545-15	Not required	Pb $< 0,8 \text{ mg/dm}^2$ Cd $< 0,07 \text{ mg/dm}^2$	

		EN 14411, annex L BIII GL – Catalogue number: Wxxxxxxx wall tiles				EN 14411, annex H BIb GL – Catalogue number: GARJDxxx compact floor tiles				EN 14411, annex G BIa GL, UGL – Catalogue number: Dxxxxxxx, Gxxxxxxx, Txxxxxxx fully vitrified floor tiles															
Technical characteristics	Norm	Standard requirements EN 14411 annex L BIII GL (max. value)				Parameters LB (max.)				Standard requirements EN 14411 annex H BIb GL (max. value)		Parameters LB (max.)		Standard requirements EN 14411 annex G BIa GL, UGL (max. value)			Parameters LB (max.)								
					max				max									max				max			max
 Sizes	ISO 10545-2	Length and width	±0,5 %	±2,0 mm	±0,3 %	±1,8 mm	±0,2 %	±1,2 mm	Length and width	±0,6 %	±0,4 %	Length and width	±0,6 %	±2,0 mm	±0,4 %	±1,5 mm	±0,2 %	±1,2 mm	±0,2 %	±1,5 mm					
			Thickness	±10 %	±0,5 mm	±5 %	±0,5 mm	±5 %					±0,5 mm	Thickness	±5 %	±0,5 mm	±0,5 %	±0,5 mm	±5 %	±0,5 mm	±5 %	±0,5 mm	±5 %	±0,5 mm	
			Linearity	±0,3 %	±1,5 mm	±0,2 %	±1,2 mm	±0,1 %					±0,9 mm	Linearity	±0,5 %	±0,25 %	Linearity	±0,5 %	±1,5 mm	±0,25 %	±1,5 mm	±0,1 %	±0,6 mm	±0,1 %	±1,2 mm
			Rectangularity	±0,5 %	±2,0 mm	±0,3 %	±1,3 mm	±0,2 %					±1,0 mm	Rectangularity	±0,5 %	±0,3 %	Rectangularity	±0,5 %	±2,0 mm	±0,3 %	±1,8 mm	±0,25 %	±1,5 mm	±0,2 %	±1,5 mm
 Surface flatness in the middle of the flat/edge/angles	ISO 10545-2		+0,5 % -0,3 % ±0,5 %	+2,0 mm -1,5 mm ±2,0 mm	+0,3 % -0,15 % ±0,25 %	+1,0 mm -0,7 mm ±1,0 mm	+0,2 % -0,1 % ±0,25 %	+1,5 mm -0,7 mm ±1,5 mm	±0,5 %	±0,25 %		±0,5 %	±2,0 mm	±0,25 %	±1,2 mm	±0,25 %	±1,5 mm	±0,25 %	±1,5 mm						
 Water absorption	ISO 10545-3	E > 10 %				E 10-20 %				0,5 % < E ≤ 3,0 % individually 3,3 %		E < 2,5 %		UGL: E ≤ 0,5 % individually max. 0,6 % GL: E ≤ 0,5 % individually max. 0,6 %			UGL: E ≤ 0,4 % individually max. 0,6 % GL: E ≤ 0,5 % individually max. 0,6 %								
Surface quality	ISO 10545-2	Min. 95 % of the tiles without visible defects				Min. 95 % of the tiles without visible defects				Min. 95 % of the tiles without visible defects		Min. 95 % of the tiles without visible defects		Min. 95 % of the tiles without visible defects			GL Min. 95 % of the tiles without visible defects			UGL Min. 95 % of the tiles without visible defects					
 Modulus of rupture	ISO 10545-4	Thickness ≥ 7,5 mm min. 15 N/mm ² , Thickness < 7,5 mm min. 12 N/mm ²				≥ 7,5 mm min. 15 N/mm ² < 7,5 mm min. 12 N/mm ²				Min. 30 N/mm ² . Individual min. 27 N/mm ²		Min. 35 N/mm ² . Individual min. 32 N/mm ²		Min. 35 N/mm ² . Individual min. 32 N/mm ²			Min. 35 N/mm ² . Individual min. 32 N/mm ²			Min. 35 N/mm ² . Individual min. 32 N/mm ²					
 Breaking strength	ISO 10545-4	Thickness ≥ 7,5 mm min. 600 N, Thickness < 7,5 mm min. 200 N				≥ 7,5 mm min. 600 N < 7,5 mm min. 200 N				Thickness ≥ 7,5 mm min. 1 100 N, Thickness < 7,5 mm min. 700 N		Thickness ≥ 7,5 mm min. 1 300 N Thickness < 7,5 mm min. 900 N		Thickness ≥ 7,5 mm min. 1300 N, Thickness < 7,5 mm min. 700 N			Thickness ≥ 7,5 mm min. 1300 N Thickness < 7,5 mm min. 700 N			Thickness ≥ 7,5 mm min. 1300 N Thickness < 7,5 mm min. 700 N					
 Thermal shock resistance	ISO 10545-9	Not required				Resistant				Not required		Resistant		Not required			Resistant			Resistant					
 Frost resistance	ISO 10545-12	Not required				Not frost resistant				Required		Fully frost resistant		Required			Fully frost resistant			Fully frost resistant					
Crazing resistance for glazed tiles	ISO 10545-11	Required				Resistant				Required		Resistant		Required GL			Resistant			Resistant					
 Slipperiness - coefficient of friction	EN 16165:2021 DIN 51130 DIN 51097 ČSN 725191	Not required				Not required				Manufacturer to state value and test method used		Not tested		Manufacturer to state value and test method used			μ ≥ 0,3 Selected types group R9 – R13, A – C, μ ≥ 0,5			μ ≥ 0,3 Selected types group R9 – R13, A – C, μ ≥ 0,5					
 Deep abrasion resistance	ISO 10545-6	Not required				Not required				Not required		Not required		Glazed Not required			Unglazed Max. 175 mm ³			Not required			Max. 135 mm ³		
PEI Deep abrasion resistance	ISO 10545-7	Not required				Not required				Manufacturer to state classification (cl. PEI 1-5)		Not tested		Manufacturer to state classification			Not required			As shown in catalogue			Not required		
 Surface hardness according to Mohs scale	ČSN EN 101	Manufacturer to state classification				Min. cl. 3				Manufacturer to state classification		Min. cl. 5		Manufacturer to state classification			Min. cl. 5			Min. cl. 7					
Coefficient of linear thermal expansion (20-100 °C)	ISO 10545-8	Not required				Max. 8 × 10 ⁻⁶ K ⁻¹				Not required		Max. 8 × 10 ⁻⁶ K ⁻¹		Not required			Max. 8 × 10 ⁻⁶ K ⁻¹			Max. 8 × 10 ⁻⁶ K ⁻¹					
 Resistance to various chemicals used in household	ISO 10545-13	Min. B				Min. A				Min. B		Min. A		Min. B			Min. B			Min. A			Min. A		
 Resistance to low concentrations of acids and alkalis	ISO 10545-13	Manufacturer to state classification				Min. cl. B				Manufacturer to state classification		Min. B		Manufacturer to state classification			Min. B			Min. A					
 Resistance to high concentrations of acids and alkalis	ISO 10545-13	Not required				Min. cl. B				Not required		Min. B		Not required			Min. B			Min. A					
 Resistance to staining	ISO 10545-14	Min. cl. 3				Min. cl. 3				Min. cl. 3		Min. cl. 3		Min. cl. 3 for GL Not required for UGL			Min. cl. 3			NPD*					
 Release of dangerous substances	ISO 10545-15	Not required				Pb < 0,8 mg/dm ² Cd < 0,07 mg/dm ²				Not required		NPD*		Not required			NPD*			NPD*					

4. LAYING OF TILES

For ceramic tile laying, it is necessary to adhere to the approved rules according to valid standards, in particular, 268/2009 Coll., CSN 73 3451 General rules for designing and laying ceramic tiles, and CSN 74 4505 Floors. We use system solutions and RAKO SYSTEM recommended building chemistry, and work procedures as described at www.rako.cz/en/for-professionals.

4.1 SUBSTRATE PREPARATION BEFORE LAYING

An essential prerequisite for the commencement of paving work is the preparation of a stable and level base, which must have sufficient strength and must be free of dust, grease stains and excess water. The concrete substrate must be dry and firm with a minimum curing period of 28 days. The moisture content of the floors should not exceed the specified values according to CSN 73 3451, see Table 6. According to CSN 12 570, the only permissible method of measurement is the gravimetric method (by drying). For non-industrial floors, the quality of the concrete subfloor is required to correspond to the strength class according to EN 206-1C20/C25, which guarantees a minimum compressive strength of 20/25 MPa. For industrial floors, the standard requires a strength class of C40 (40 MPa). Permissible limit deviations of the overall subfloor flatness for dry construction (EN 73 0205) and non-dry construction (CSN 13 670) can be found in Table 7. Uneven substrates must always be levelled and treated with special trowels, screeds or levelling compounds. Unstable and flexible substrates (SK boards, OSB boards and Cetriss boards) must be reinforced with load-bearing grids to prevent deflection. The tension between the substrate and the ceramic tiles is then absorbed by the applied separating panels or membranes. In the case of moisture-laden areas, the substrate is applied before laying waterproofing screeds are applied.

Tab. 6

Maximum substrate moisture content CSN 73 3451	
Floors - subfloors	
Indoor cement-based tiles	max. 5 %
Indoor cement-based tiles with floor heating	max. 4.5 %
Indoor tiles with large formats	max. 2.5 %
Outdoor tiles	max. 3 %
Floors based on calcium sulphate (anhydrite)	max. 0.5 %
Anhydrite with floor heating	max. 0.3 %
Plaster - substrates	
Cement base plasters	max. 4 %
Lime-cement base plasters	max. 3 %
Gypsum base plaster	max. 2 %

Tab. 7

Dry construction CSN 73 0205	Limits of deviation of the overall flatness of the substrate type SK, OSB (+/- per 2m batten)		
	Side length up to 4 m	Side length > 4m-10m	Side length > 10m
Residential rooms	4 mm	6 mm	8 mm
Other rooms	6 mm	10 mm	15 mm

Not dry construction CSN 74 4505	Limit deviation of the overall flatness of the concrete base (+/- per 2m battens)
	2 mm

4.2 TILE CUTTING AND DRILLING

RAKO wall tiles can be cut with commonly available classic lever-operated cutters. Vitrified floor tiles have great material hardness (7 on the Mohs hardness scale). When cutting these materials, professional lever-operated cutters, cutters with guide bars and diamond wheels intended for vitrified ceramic tiles, are recommended, see Fig. 3. Cutting accuracy is ensured by the stability of cutting tools, by secure clamping of the material being cut, and by the minimum clearance of cutters. Portable cutters and grinders for the creation of jolly edges, fillets, or veneers, copy tile edges and create uniquely processed edges, see Fig. 4 and 5. To cut tiles with a thickness of 2 and 3 cm, water-cooled stand saws have proved to be the most effective, see Fig. 2.

When drilling and cutting holes into vitrified bodies, diamond hole saw bits intended for this type of material (identified as GRES PORCELLANATO, PORCELAIN, STONEWARE, or FEINSTEINZEUG) are used, see Fig. 1. The RAKO vitrified body is more than two times harder than a traditional tile body. When drilling holes into sintered ceramic tiles, drills with steel tips are not recommended. Proceed according to the manufacturer's instructions (speed, water cooling, etc.). However, a bit can be damaged by striking the base construction material (e.g. brick, concrete or stone). When drilling into base materials, it is therefore good to use a classic bit with a steel tip and a drill set with the hammer function.

Fig. 1 – Hole saw bits for vitrified floor tiling



Fig. 2, 3 – A stand saw for wet cutting of wall and floor tiling; a diamond wheel for vitrified floor tiling



Fig. 4 – A cutter with a guide bar



Fig. 5 – A hand-held cutter and grinder for jolly edges, fillets, and veneers for vitrified floor tiling



5. CONTACT LAYING

5.1 CERAMIC TILES BONDING

Ceramic tiles bonding with a thin layer of adhesive is a laying procedure for flat stable substrates made of concrete, anhydrite, core plaster, plasterboard or precision blocks. The application of the adhesive is not used to level unevenness of the substrate, for this we use levelling screeds and screeds. Insufficient coverage of the tiles with adhesive is then one of the most common hidden laying defects. It causes low adhesion of the tiles to the adhesive and to the substrate and creates air voids in the applied adhesive. These cause moisture to condense in these voids (resulting in tile tear-off) and reduce the resistance of the tiles to breakage.

We reduce these risks by using C2/S1 adhesives that have a minimum adhesion strength of at least 1 MPa and are deformable (flexible) according to EN 12 004. Such adhesives can absorb horizontal movement between the substrate and tiling from 2.5 mm to 5.0 mm. We further limit such risks by the way the adhesive is applied. It is applied to the substrate in one direction, or in the case of double-sided bonding (buttering floating) on the reverse side in the same direction as the substrate, see Fig. 6. The method of adhesive application is also influenced by the size of the ceramic tile formats.

For example, according to the ÖNORM B 3407 standard, tiles from 45 × 45 cm can be considered large formats. We recommend single-sided gluing in a standard bed for small formats, for plinths and interiors where we should achieve a tile coverage of at least 65 %. For the large formats, showers, moisture-laden buildings, underfloor heating and exteriors, we recommend instead applying double-sided gluing to the standard bed or single-sided gluing to the liquid bed. There the tile coverage of the adhesive should be 90 %.

Another factor influencing sufficient tile coverage is the choice of the correct height and tooth profile of the trowel. For laying small formats in a standard bed, use a lower adhesive layer and a tooth height in the range of 6-8 mm. For large formats in a standard bed (not applicable for ceramic tiles) we use a higher adhesive layer and a tooth height of 10-12 mm, and for the reverse of the tile a tooth height of 4-6 mm. The worst results when covering tiles with adhesive in the standard bed are achieved when using trowels with a perpendicular tooth profile. On the other hand, better results are obtained with a trowel with an inclined tooth or with so-called K tooth, see Fig. 12.

If we use a trowel with a semicircular tooth in the liquid bed, we recommend a tooth height of at least 12 mm. Spacers are used during the actual laying to ensure regular joints. Levelling wedges can then be used to ensure that the laying is even, see Fig. 6. To avoid chipping edges and scratching the tiles when applying levelling wedges, we use the manufacturer's recommended pads under the wedges, see Fig. 11. The tolerance for the flatness of the walking laying layer in areas for permanent residence of persons is according to ČSN 74 4505 +/- 2 mm per 2 m length of the batten.

Rectangular ceramic tiles may be slightly curved in accordance with the standard. These permissible deviations can be eliminated when laying on a bond, avoiding the joint in the middle of the adjacent ceramic tiles. It is recommended to offset the ceramic tiling element by 1/3, see Fig. 8 and 9. The maximum permitted overlap (height difference) between ceramic tiles in the joint according to ČSN 73 3451 is max. 1 mm for joints less than 6 mm wide and max. 2 mm for joints with a width of at least 6 mm or more. When handling large ceramic tiles, special suction cups facilitate handling, see Fig. 7.

Tiling of round corners with mosaic tiles

If outer and inner round corners are tiled with mosaic tiles, try to avoid opening or closing the joints when bending. First, apply a reinforced foil (such as 3M 8959 foil) to the front side of mosaic tiles. Then, turn the mosaic tile and cut the plastic mesh with the adhesive with a knife in the joints. When applied into the adhesive, mosaic tiles have the same joint at deflection as outside it. This will prevent opening the visible joint. When the adhesive has dried, tear the foil off from the mosaic tile face.

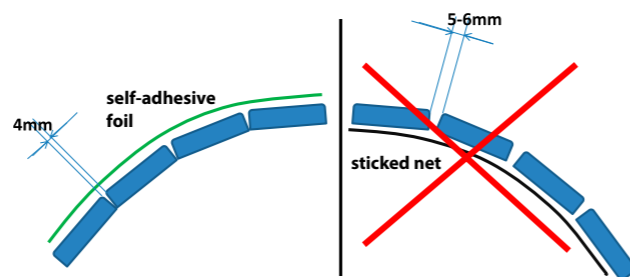

Fig. 6 – Levelling wedges

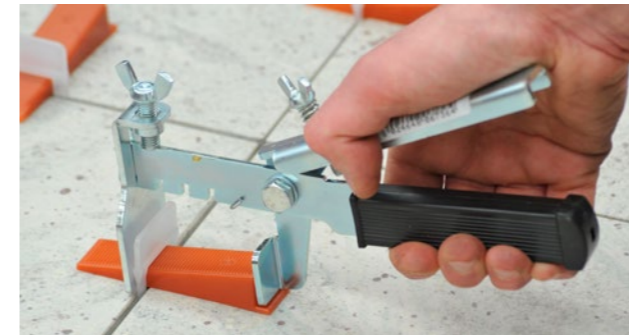

Fig. 7 – Suction clamping elements for large formats



Fig. 8 – Recommended stretcher bond layout

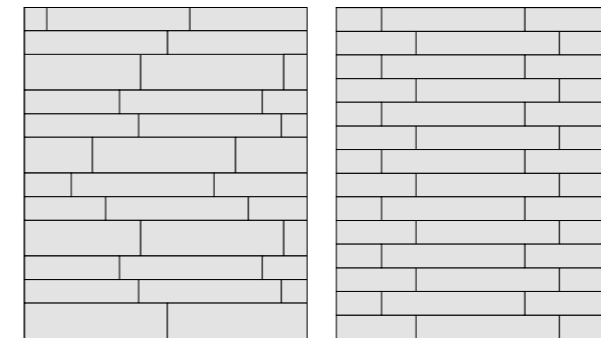

Fig. 9 – Stretcher bond layout not recommended

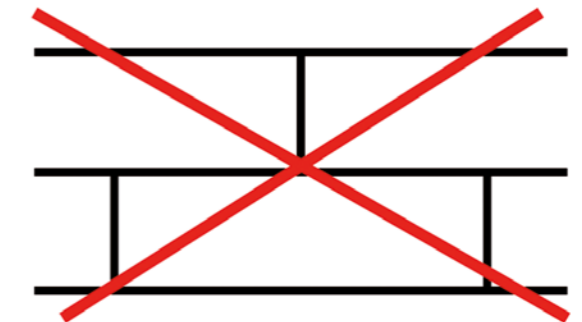

Fig. 10 – Buttering-floating bonding



Fig. 11 – Washers under the levelling wedges



Fig. 12 – Trowel with perpendicular tooth, with inclined tooth, with K tooth, and with semicircular tooth



Recommended combinations of modular sizes

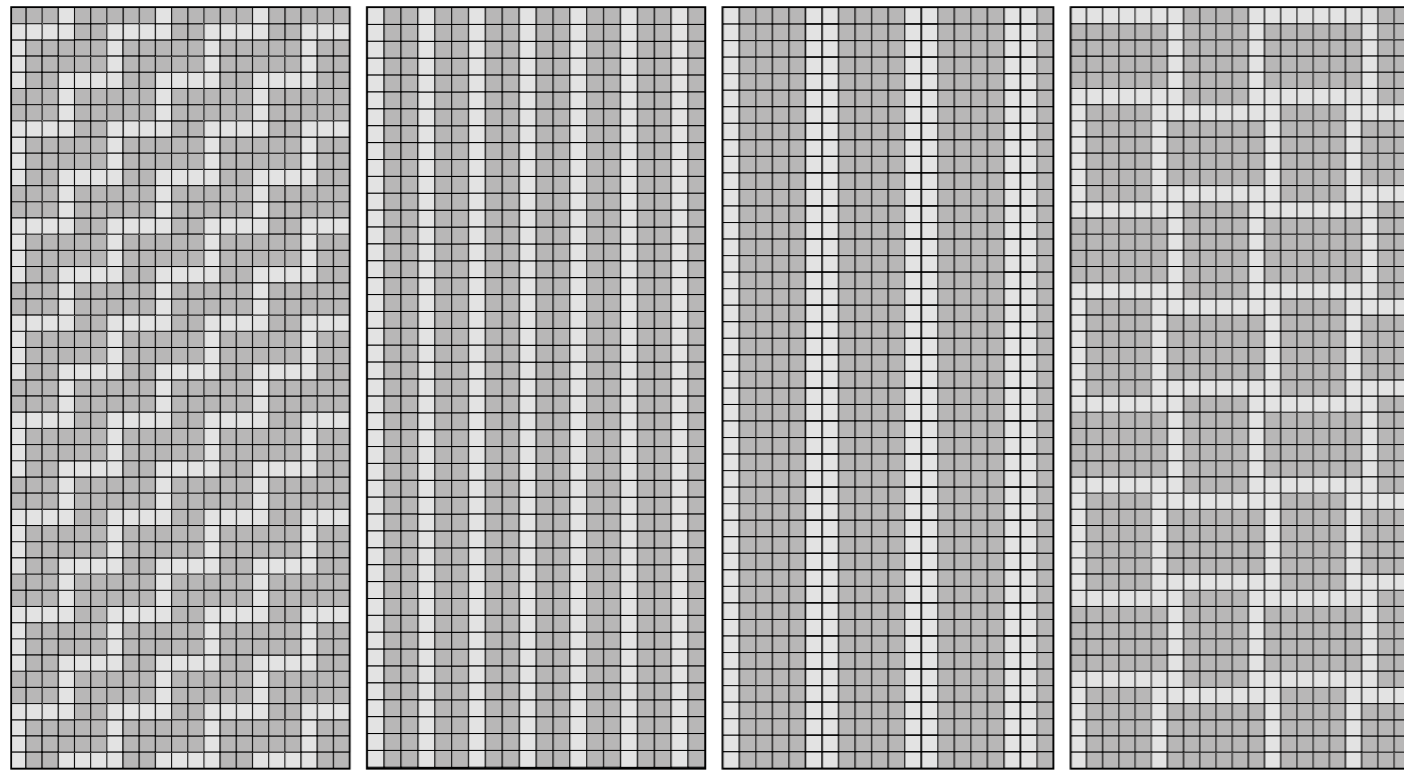

VEIN 5 x 5 | 30 x 30

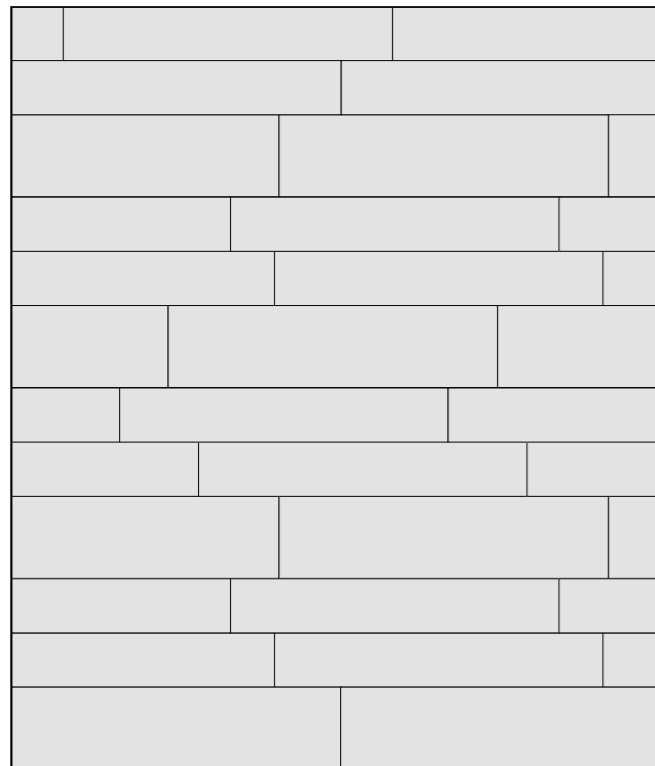
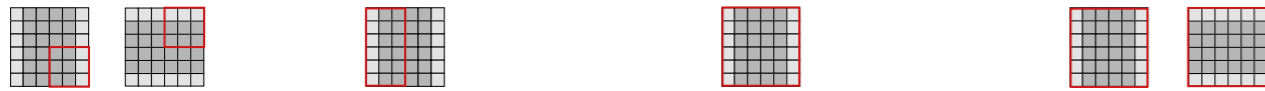

20 x 120 = 57%, 30 x 120 = 43%

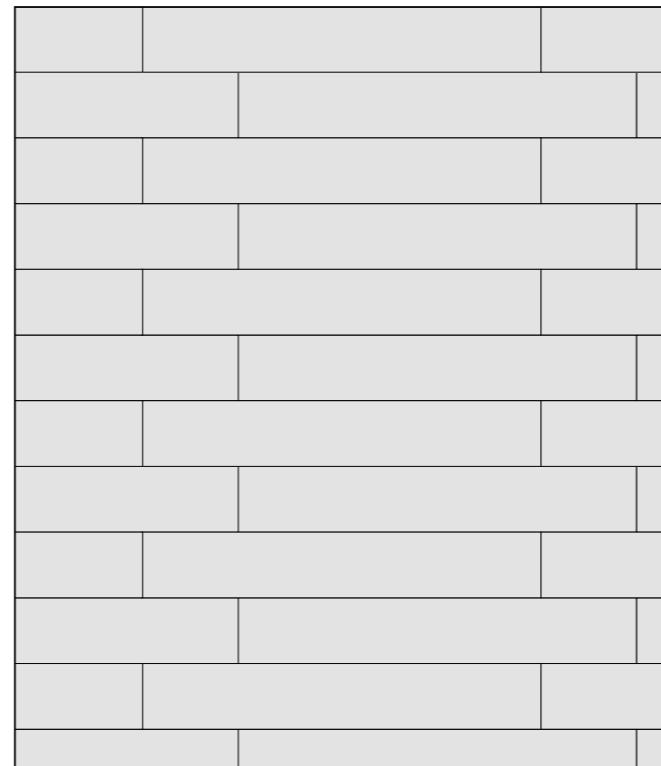

20 x 120 | 30 x 120 20 x 80 15 x 60

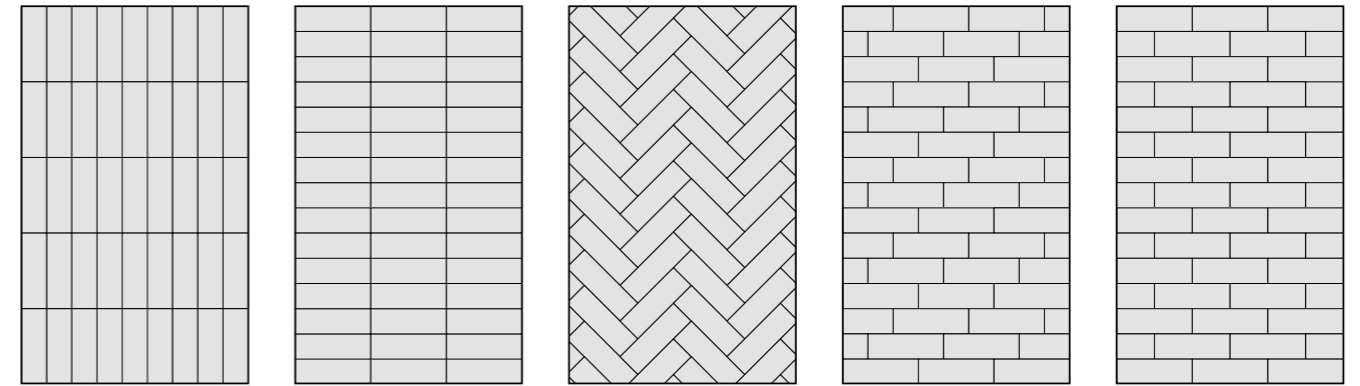

10 x 30

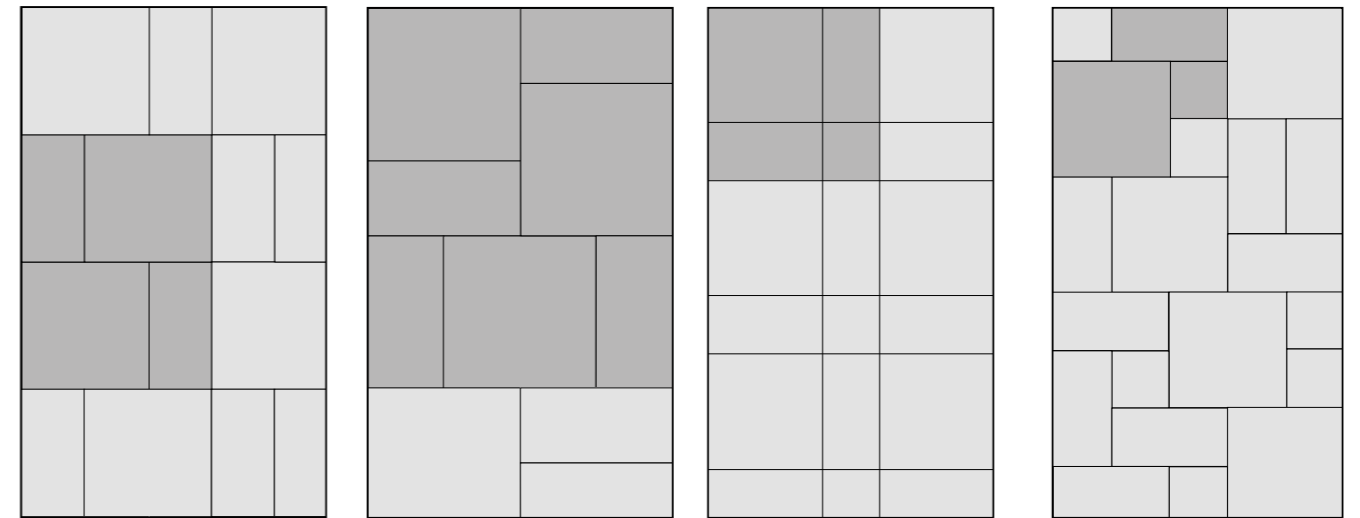

60 x 60 = 66,7%, 30 x 60 = 33,3%
80 x 80 = 66,7%, 40 x 80 = 33,3%
30 x 30 = 66,7%, 15 x 30 = 33,3%

60 x 60 = 60%, 30 x 60 = 40%
80 x 80 = 60%, 40 x 80 = 40%
30 x 30 = 60%, 15 x 30 = 40%

45 x 45 = 45%, 22,5 x 45 = 45%,
22,5 x 22,5 = 10%

45 x 45 = 57%, 22,5 x 45 = 29%,
22,5 x 22,5 = 14%

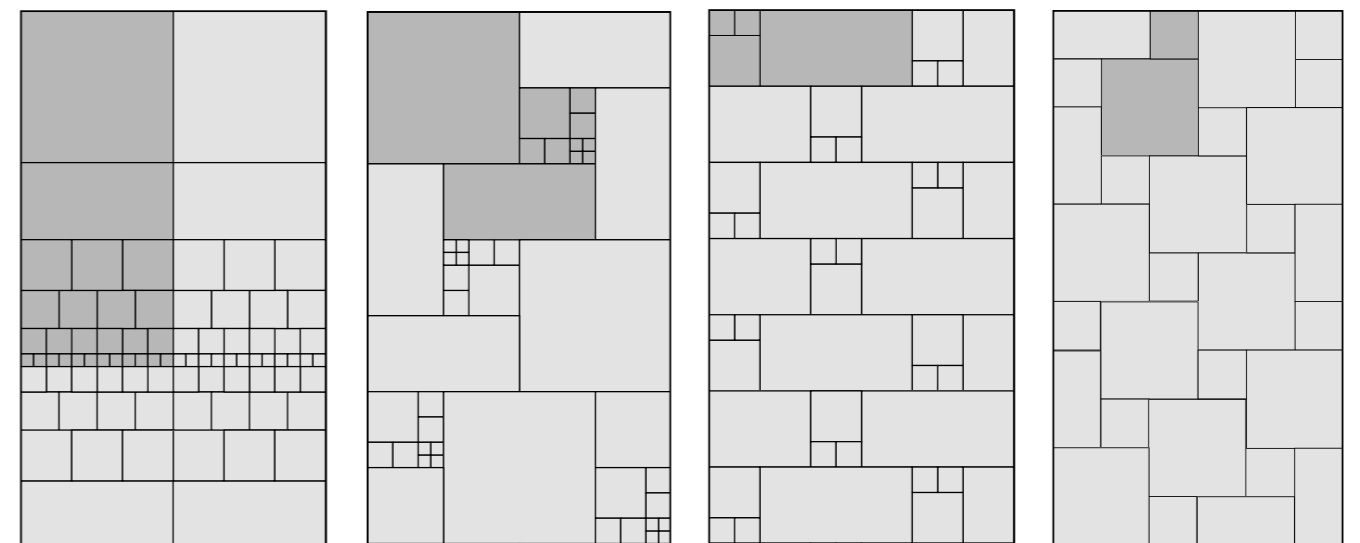

60 x 60 = 42,9%, 30 x 60 = 21,4%,
20 x 20 = 14,3%, 15 x 15 = 10,7%,
10 x 10 = 7,1%, 5 x 5 = 3,6%

60 x 60 = 57,1%, 30 x 60 = 28,6%,
20 x 20 = 6,3%, 10 x 10 = 6,3%,
5 x 5 = 1,7%

30 x 60 = 75%, 20 x 20 = 16,7%,
10 x 10 = 8,3%

45 x 45 = 80%, 22,5 x 22,5 = 20%

5.2 UNDERFLOOR HEATING

Underfloor heating has a number of advantages. It enables ideal distribution of temperature in the heated room. For heating with a stove or common central heating, the difference between air temperatures at the floor and at the ceiling is up to 8°C, while for underfloor heating, the air temperatures throughout the space are constant and heat comfort is achieved even by lower temperature in the heated room. Energy savings are achieved through the operation of underfloor heating. Because the system heating water is used at lower temperatures (approx. 40 °C) than in other heating systems, it is also possible to use low-temperature heat sources. Year-round energy consumption with underfloor heating compared to radiators in a comparable interior heated in the same way is different. Underfloor heating can save up to 20% of energy all year round. Underfloor heating can reduce the temperature by 1 °C without affecting the thermal comfort. By using the RAKO SYSTEM DMEM separation membrane we can improve the function of the underfloor heating system. Thanks to the membrane we can achieve a more even temperature distribution on the floor.

In addition, ceramic tiles have a favourable thermal conductivity with the ability to store and radiate heat as opposed to PVC and vinyl floors, see 3.8 THERMAL PROPERTIES. If, for underfloor heating with tiles, we need to achieve 20 °C indoors, it is sufficient to set the water temperature in the heating circuit to 37 °C. If we have floor heating installed LVT vinyl planks with a lock, we need to set the water temperature to 40 °C. If we have LVT vinyl HDF boards installed, we need to set the water temperature to 47 °C, see diagram Water temperatures of underfloor heating depending on the covering used. In general, lowering the supply water temperature by 1 °C will save approximately 3% of the heating energy.

WATER TEMPERATURE OF FLOOR HEATING DEPENDING ON THE FLOOR COVERING USED

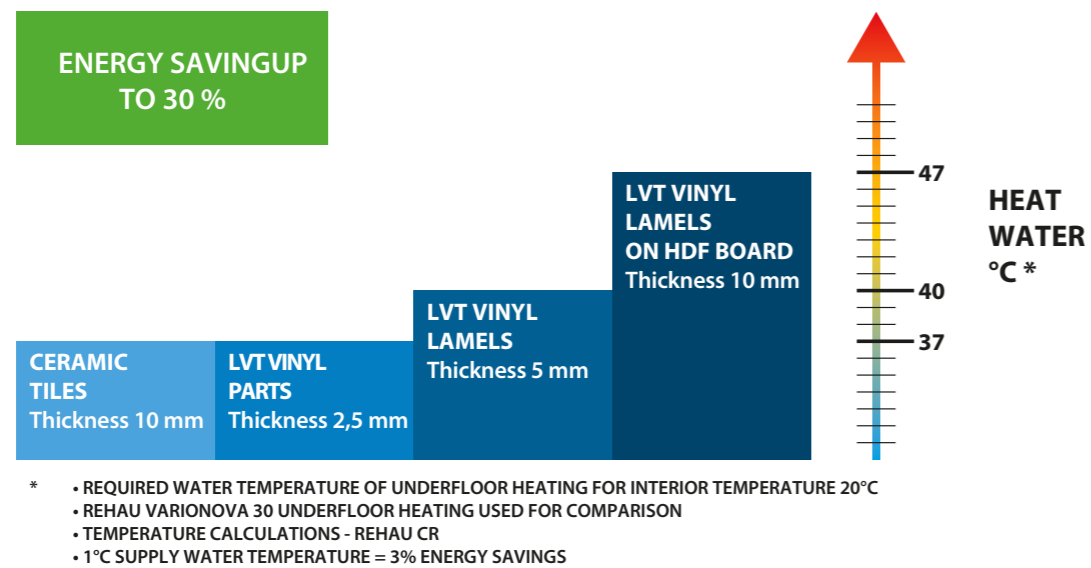

Example of water-based underfloor heating



Due to the concrete slab, underfloor heating systems have substantial thermal inertia. Therefore, the temperature is controlled by programmable controllers. For health reasons, the surface temperature of floors should not continually exceed 29°C. **The recommended tiles for underfloor heating include all RAKO floor tiles, as well as large format floor tiles.**

Electric floor heating

Floor heating cables and mats can be conveniently used for accumulation and tempered heating of thin floors in interiors, or for defrosting systems. There are two types of electric floor heating: with base plates and heating mats. Fig. 13 shows a system for the use of base plates for the installation of electric heating cables. To avoid heat loss into the floor, base plates with built-in thermal barriers can be used, see Fig. 14. The mat with heating cables can be underlaid with RAKO SYSTEM DSDI plates as thermal insulators, see Fig. 15. In the case of floor heating, the RAKO SYSTEM, type C2TE S1 and CG2WA, flexible adhesive and grouting materials are recommended.

Fig. 13 – System of floor heating cables placed on a base plate (Figure: Schlüter-Systems)

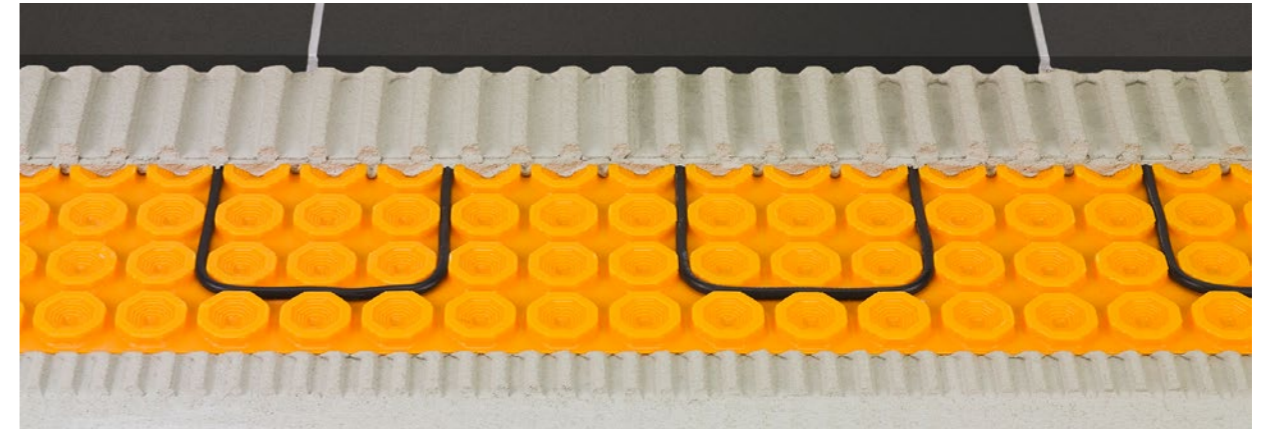

Fig. 14 – System of floor heating cables placed on a base plate with a built-up thermal barrier (Figure: Schlüter-Systems)

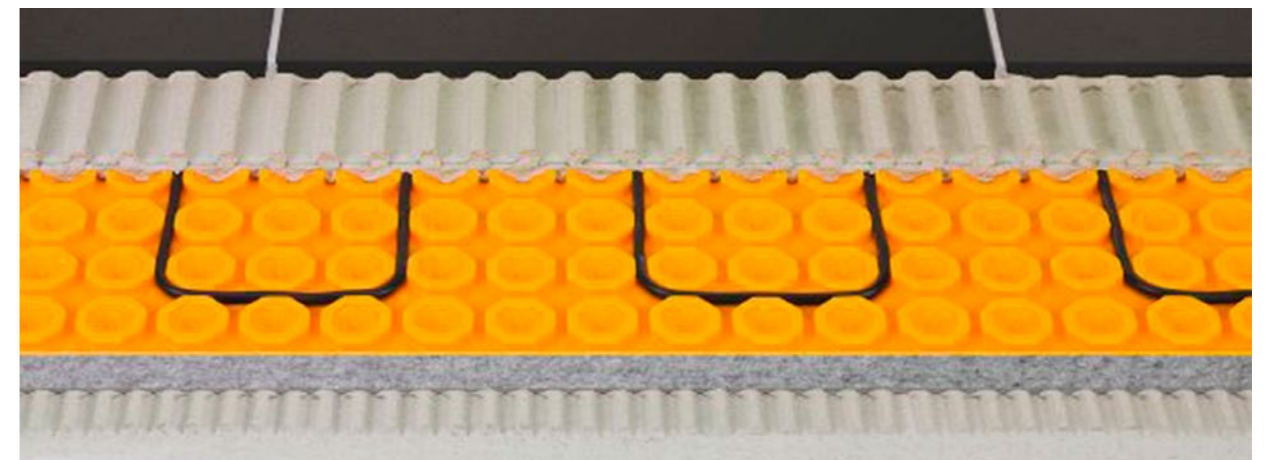

Fig. 15 – Electric mat with heating cables and DSDI plates as thermal insulation



Water-based underfloor heating

Water-based underfloor heating is the most widely used version of underfloor heating. When using ceramic tiles as the flooring, the water-based underfloor heating output is about 80 W/m² (pipe spacing 150 mm, interior temperature 20°C, and input temperature 40°C). For carpet flooring, the output may drop by 25 %. Temperature of floor heating water should not permanently exceed 50°C.

When implementing water-based underfloor heating, wet or dry systems can be used.

For the wet system, several specific procedures should be considered. Concrete or anhydrite materials should cover the floor heating pipes placed on support plates. As standard, the height of concrete above the heating circuit is around 45 mm, see Fig. 16 and 17. A plasticizer may be added into the concrete filler to ensure better contact with plastic pipes. The heating plate must be separated from the external walls with expansion joints, as well as the adjoining heating circuits. For interiors with a low structure height, thin-layer hot-water underfloor heating is recommended with a carrier plate, and the layer of screed of up to 20 mm, see Fig. 18. A pressure test must be completed before concreting, and the pipes must be kept pressurised until the plate is fully hardened (21 days for concrete). Water content in concrete should be less than 4.5 %, respectively less than 0.3 % in anhydrite. To increase the heating efficiency, standard EPS plates can be placed under heating plates. To improve the heating efficiency we can underlay the heating plates with standard EPS plates.

At the dry thin-layer underfloor heating system, EPS heating plates are used for the installation of heating pipes, which are covered with 2 layers of gypsum-fibre boards, see Fig. 19. Before applying the adhesive to gypsum-fibre boards, apply RAKO SYSTEM P203 filler.

When cementing tiles for underfloor heating, the flexible adhesive RAKO SYSTEM AD530, class C2TES1, is used. After the time period prescribed by the adhesive manufacturer, the tiles are jointed with the RAKO SYSTEM GFDRY flexible grouting material. For underfloor heating, it is necessary to make dilatation joints using the silicone or polyurethane sealants RAKO SYSTEM ASI according to the valid standards (such as CSN 74 4505), see Chapter 6. GROUTING OF TILES AND DILATATION. The maximum spacing of dilatation fields for thermally stressed surfaces should be 3m with a maximum ratio of the sides of 1:1.5.

Also, the first heating must be gradual, and the temperature in the system may grow by only 5°C in 24 hours. After the operating temperature is achieved, its reduction must also be gradual, or else the pipes may separate from the concrete and thus reduce the heat transfer and the power output. Underfloor heating should be performed by a reputable construction company, while following the instructions for use provided by underfloor heating suppliers.

Fig. 16 and 17 – Picture and cross-section of water-based underfloor heating

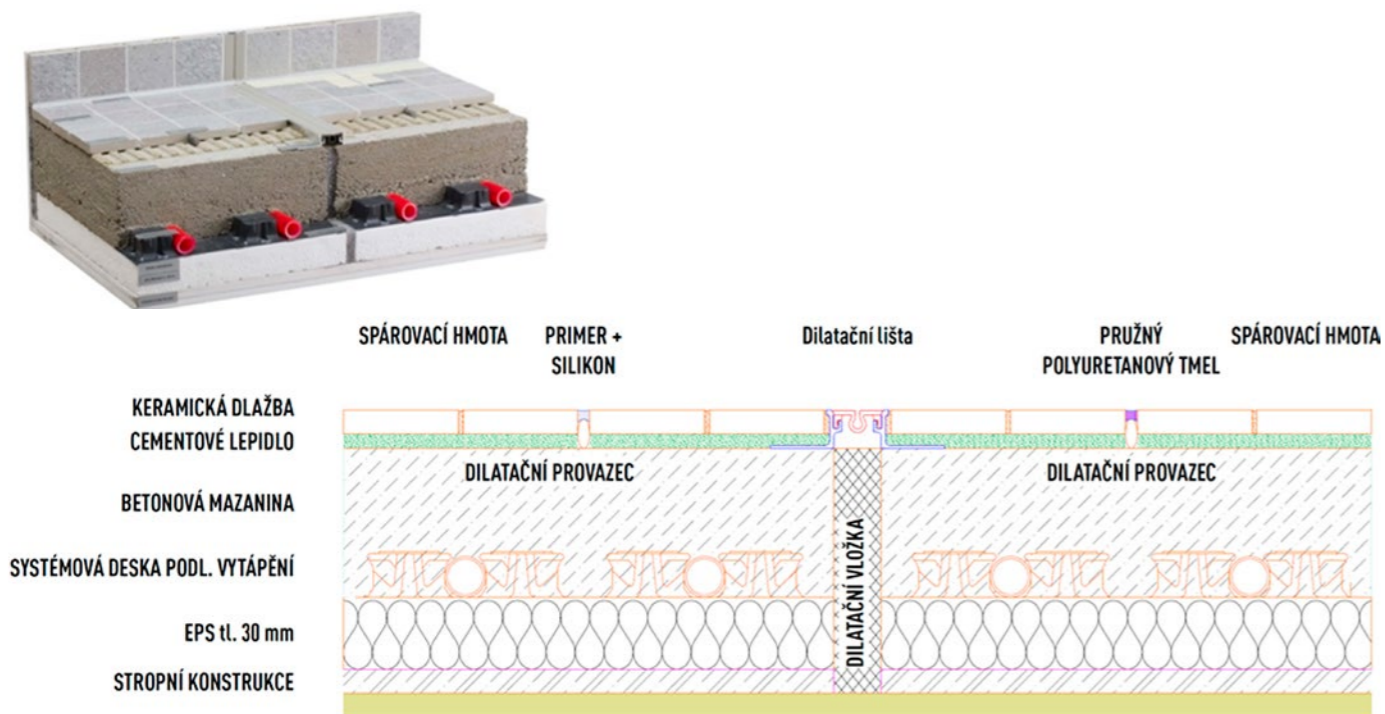

Fig. 18 – Thin-layer water-based hot-water underfloor heating (Figure: Schlüter-Systems KG)

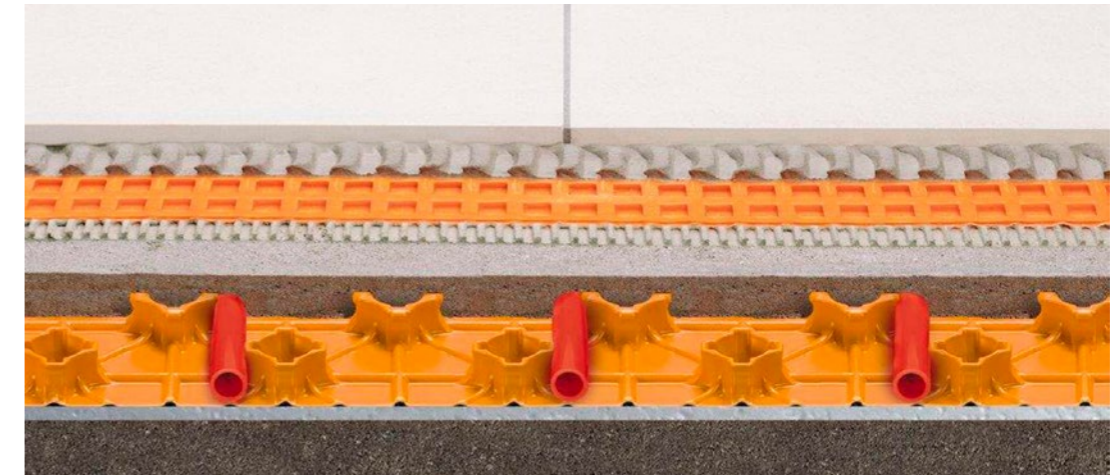

Fig.19 – Dry system of thin-layer water-based underfloor heating



5.3 STAIRS

For indoor or outdoor staircases, we suggest the use of stair treads or custom-made stair fittings, see Fig. 20. For outdoor use, we recommend the use of R10 and R11 slip-resistant stair treads.

The requirements for slip resistance of staircases in the Czech Republic are specified by Decree 268/2009 Coll. and standard ČSN 73 4130, Staircases and inclined staircases ramps. The required minimum coefficient of shear friction for interior staircases is 0.5 μ dry and 0.5 μ wet in the exterior. The edge of the tread (4 cm) at the outer corner of the staircase should then be 0.6 μ . If outdoor areas, this value is required in wet conditions. Higher values are achieved by cutting grooves at the edge of the staircase. Stair fittings without slotted grooves must guarantee a value for the shear friction coefficient 0.6 μ over the entire footprint. Requirements for identical height of all stair treads, continuity with surrounding floor and other installation details are specified in EN 73 4130.

The requirements for slip resistance of staircases in Germany are specified in ASR 1.5.Stairs GUV-I 561 of the German Social Accident Insurance (DGUV) and Functional, Safe and user-friendly stairs of the Federal Institute for Occupational Safety and Health. For buildings constructed according to DIN 18040-1, additional measures must be taken into account. These include the reliable marking of the edges of the stairs in compliance with contrast values and effects according to DIN 32 984, see chapter 3.12 OPTICAL PROPERTIES.

In Austria, the construction and design of staircases is regulated in ÖNORM B 1600. Requirements for the use of contrasting colours for staircases are not specified in the Czech Republic. Safety stair elements with RAKO base in contrasting colours and with anti-slip grooves from the Taurus COLOR product range offer safe orientation in buildings, see Figure 20.

Fig. 20 Step tiles, special step tiles and step pieces with riser

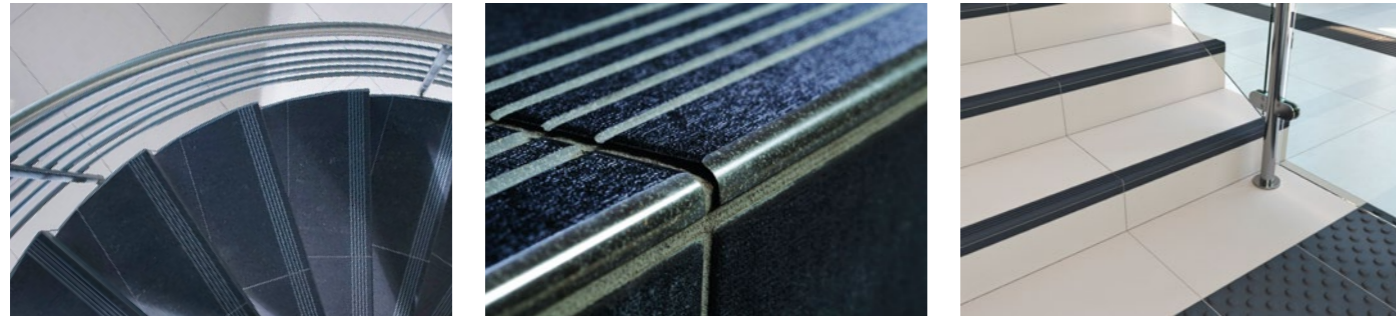

step piece with riser | TCPVN... | 598x50x10 mm | 598x20x10 mm |



TCPVN010



TCPVN019

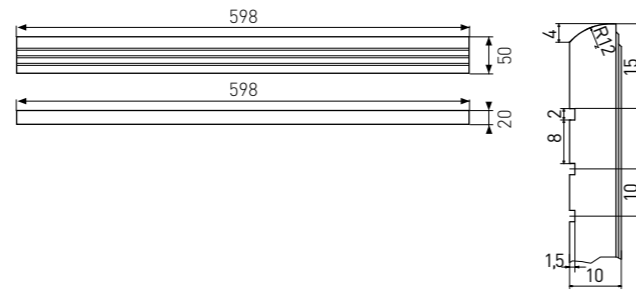
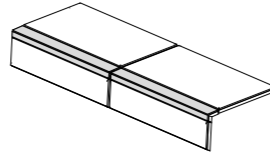

special step tile | DCF84... | 398x798x10 mm

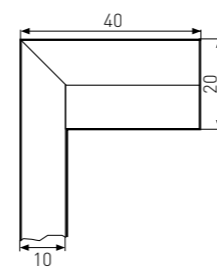
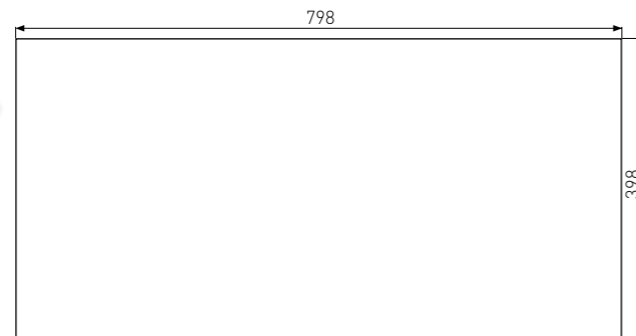

5.4 APPLICATION OF CERAMIC PLINTHS

The best-selling fittings related to paving are ceramic plinths. During floor maintenance, they protect the walls from contamination. In addition, dust does not settle on the rounded top edge of the plinth. RAKO offers plinths matched to with the colour shade and size of the tiles. Many craftsmen make plinths by cutting and grinding from tiles. Cutting and edging edge of these plinths, however, do not usually reach the quality of industrially produced products. We therefore recommend choosing from the standard catalogue offer:

1/ Skirting plinth

- Taurus GRANIT, Taurus COLOR, RAKO HOME series

Skirting plinth | TSASZ... | 598x95x10 mm |

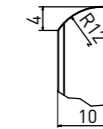
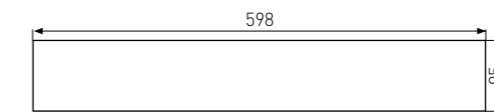

2/ Cove skirting, outside corner skirting plinth and inside corner skirting plinth

Advantages of a plinth with a rebate: the rounded transition of the plinth between the wall and the floor is much less likely to trap dirt. It is a hygienic solution for kitchens or food processing plants. We can install the plinths in the corner in a double way. Either the plinth lines the wall and forms a corner, or it finishes the tiles in the wall/floor transition. The plinths with a tongue and groove are followed by external and internal corners.

- Taurus GRANIT, Taurus COLOR, ColorTWO series

cove skirting | TSPKF... | 298x80x8 mm |

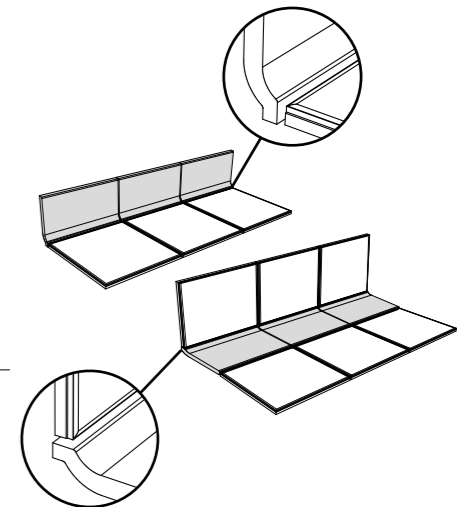
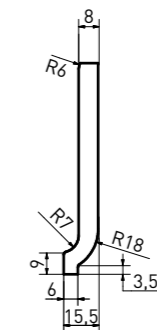
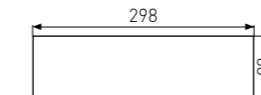

cove skirting | GST1K... | 204×198×7 mm

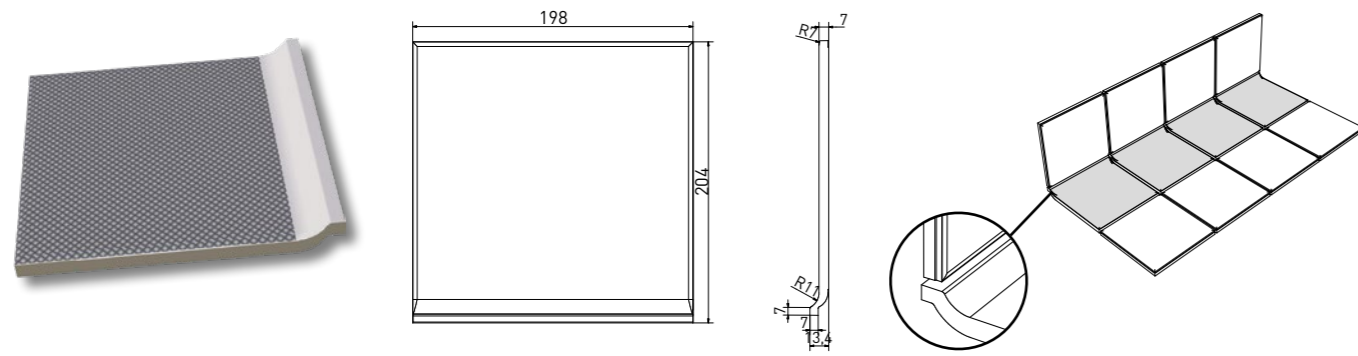

cove skirting | GSP1K... | 204×198×7 mm

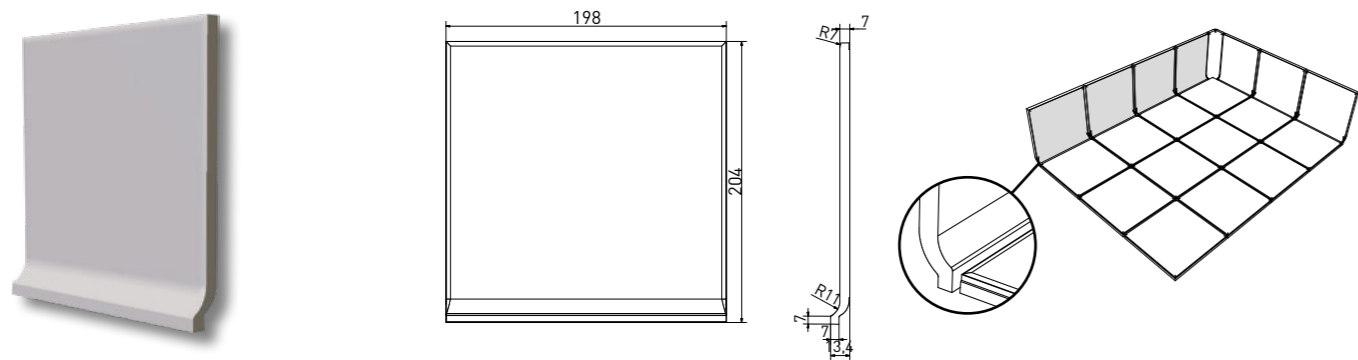

inside corner skirting plinth | TSIRH... | 80×23×10 mm



outside corner skirting plinth | TSERH... | 80×23×7 mm

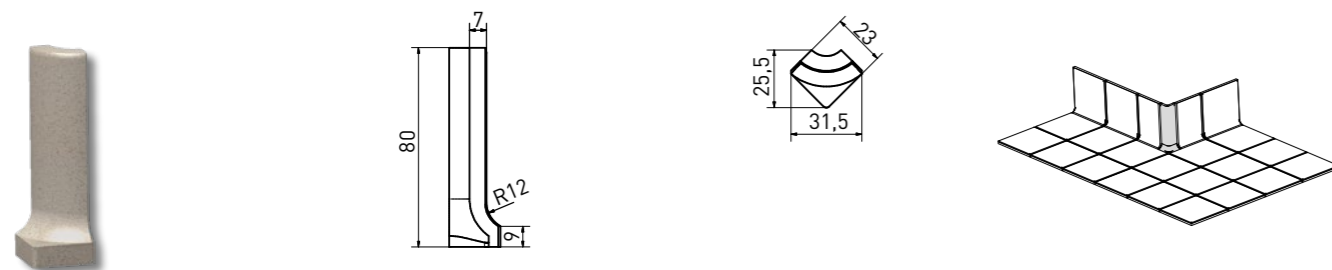

3/ French skirting plinth

Advantages of the French plinth: The bevelled transition of the skirting board between the wall and the floor traps dirt much moreless. Suitable hygienic solution for kitchens or food processing plants.

- Taurus GRANIT series

french skirting plinth | TSFKF... | 298×80×8 mm | 

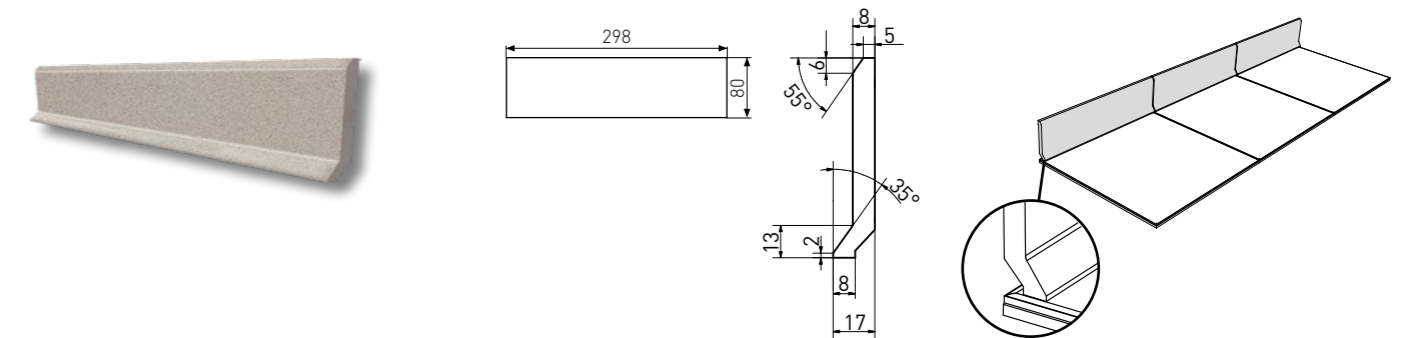

4/ Skirting - groove

Advantages of the plinth - trough: The large radius of the trough makes it suitable for the most demanding environments such as chemical laboratories or wastewater treatment plants.

- Taurus GRANIT series

skirting - groove | TSZEF... | 198×70×8 mm

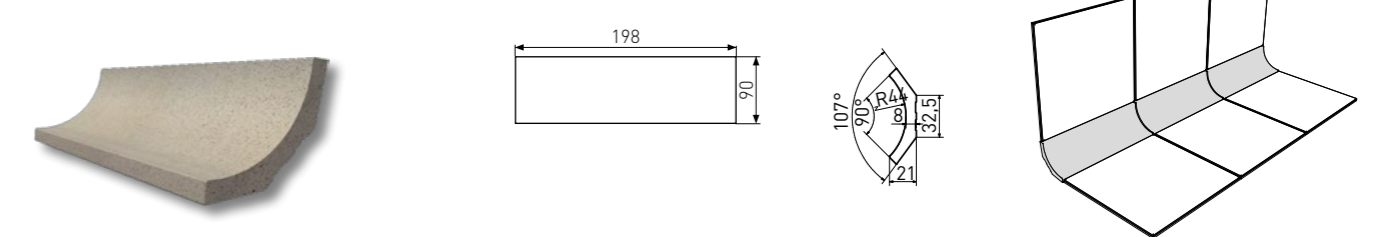

5.5 BARRIER-FREE SOLUTIONS FOR AREAS SUBJECT TO WATER LOADS

In case of a requirement for a wheelchair accessible solution for shower enclosures, swimming pools or water loaded pavements, we can use special wheelchair accessible fittings or anti-slip tiles including mosaic tiles that can follow the floor plan of the shower enclosure. The special Color TWO barrier-free fittings create a gradient for smooth water drainage, see Fig. 21, in the shower enclosure. We can also grout the ceramic tile or mosaic itself to create a gradient of at least 1.5%, see Fig. 22. Another solution is to use a grouted backing plate for the shower enclosure, see Fig. 23.

Fig. 21 –Barrier-free continuous and corner fittings including application

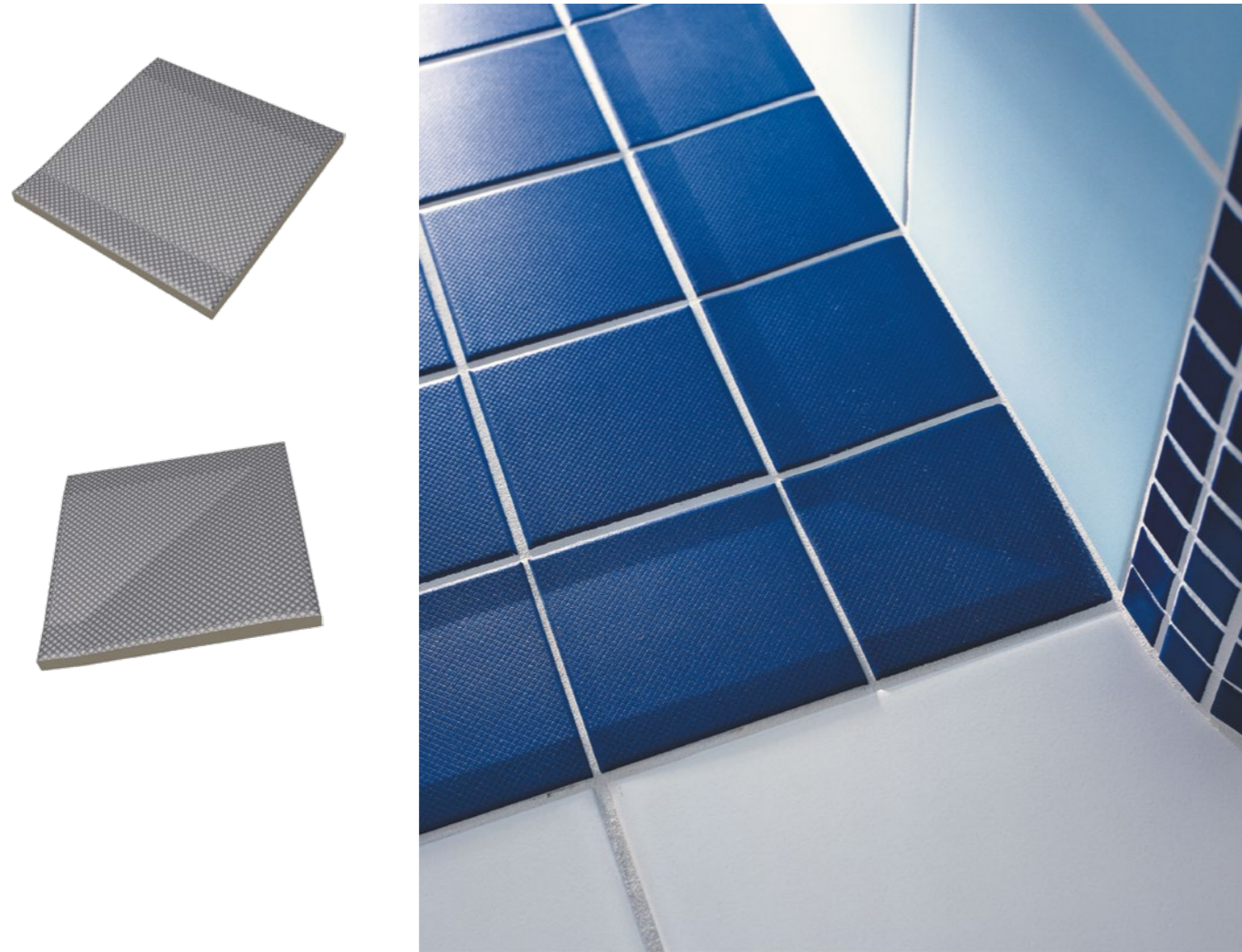

Fig. 22 – Using the 80 × 80 cm format with a flush floor

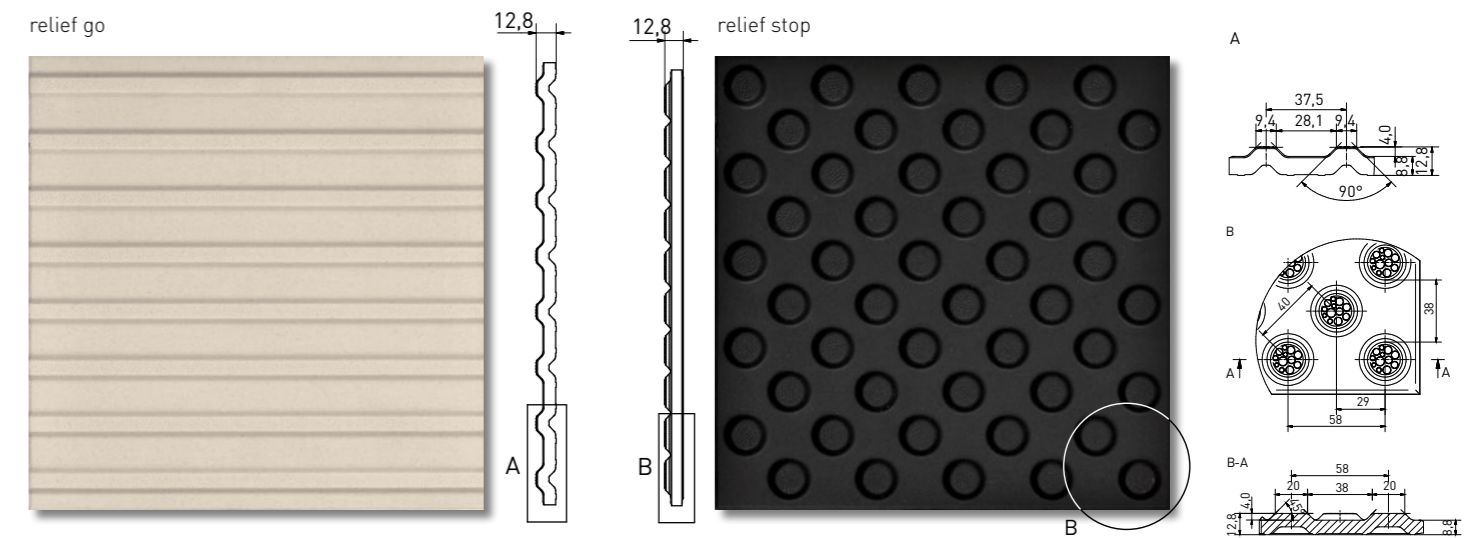

Fig. 23 – WEDI flush-mounted backing plate



5.6 BARRIER-FREE SOLUTIONS FOR THE BLIND AND PARTIALLY SIGHTED

The RAKO ceramic tile range also includes special fittings that facilitate safe movement of visually impaired people on floors. The special fittings of the Taurus COLOR series meet the requirements of the standards for floor orientation systems for blind and partially sighted persons, see 3.12 OPTICAL PROPERTIES. The range includes both directional fittings with guide strips and stop fittings with projections. Our products are offered in 2 colour contrasts (ivory and black).



6. GROUTING OF TILES AND DILATATION

6.1 NON-FLEXIBLE JOINTS

The grouting can be performed once the adhesive has hardened sufficiently. When using these, it is necessary to observe the manufacturers' instructions, and the correct amount of mixing water. The width of joints depends on the size and type of tiles. Recommended optimum widths for inflexible joints range from 2 to 5 mm. Rectified floor tiles marked with an icon  have very small dimensional deviations, and allow laying with a narrow joint width of as little as 2 mm. Joints narrower than 2 mm, and the laying of tiles without joints, are not recommended. Microscopic gaps in the case of laying with no joints cause water and dirt to get between floor tiles, without the possibility of removing them. It is necessary for the grout to completely fill the joints in their entire depth, without gaps and cavities. To prevent water entering through joints into the base or sides of porous tiles, use grouting materials with reduced water absorption (class of marking of joint sealants – W). It will also help if the mixed grout is left unused before application for a certain amount of time to remove small bubbles in the mass. Before applying the grouting material, it is recommended to test the grouting on a tile sample, as its colour pigment may leave permanent traces on the ceramics. Inflexible grouting materials are divided into cement and epoxy grouting materials.

Non-flexible grouts are divided into cement and epoxy grouts.

Cement grouts

CG2WA type RAKO SYSTEM cement grouts contain mineral fillers, white cement, polymers and additives improving the processing and utility properties of the type of compound/material concerned. For the cementing of glass elements, white adhesives are used as they do not shine through the glass and grouting material. The above types of cement grouts are not resistant to higher chemical loads.

Epoxy grouts

They feature very good resistance to chemicals and mechanical stress, and very good washability. Epoxy compounds (RAKO SYSTEM GEASY) meet the required demands on high chemical and mechanical resistance, therefore, they are suitable for chemical and food-processing plants, e.g. breweries, slaughter houses, soda works, dairies, canning factories and for grouting swimming pools, wellness facilities, reservoirs, laboratory tables, and shower boxes subjected to greater water load, or for grouting wall tiles with a transparent glaze. The above-mentioned epoxy grouts are certified for contact with drinking water, which is why they are used and favoured in drinking-water treatment plants.

6.2 FLEXIBLE EXPANSION JOINTS

Expansion joints should be carried out in accordance with CSN 73 3451 and CSN 74 4505. It is always necessary to install perimeter expansion joints for wall and floor tiling. This means in the corners in wall/wall and wall/floor joints. If tiles are laid on larger surfaces in interiors, the dilatation joint separates the area to dilatation fields with a side length of maximum 6 m, they should be divided by an intermediate expansion joint; outdoors, and in the case of floors exposed to thermal stress (e.g. radiant heating, terraces, balconies and façades), intermediate joints with a maximum spacing of 3 m. The side ratio should not be greater than 1:1.5. When using larger formats outdoors (from 45 × 45 cm), we recommend that you shorten the dilatation section and, when selecting floor tiles, we recommend that you prefer light tints.

To ensure perfectly functioning flexible joints, insert a dilatation separation cord into cleaned joints (RAKO SYSTEM PES), see Fig. 24, which reduces the risk of the flexible sealant adhering on three sides in the joint. Failure to insert a separation cord into an expansion joint tends to cause cracks and fissures in expansion joints, see Fig. 26. Silicone compounds (RAKO SYSTEM ASI) are used for filling expansion joints indoors, and polyurethane elastic compounds (RAKO SYSTEM SAB) are used exclusively outdoors. The dilatation joint width should be at least 5 mm. It is necessary to translate structural expansion joints in the base pursuant to CSN 73 3451 into expansion joints in the floor and wall tiling at least in the same width as the width of the joint in the base structure. Expansion joints can also be made by means of special expansion joint strips, applied in wider, especially construction, joints, see Fig. 25 and 27.

Fig. 24 – Separation cord



Fig. 26 A cracked expansion joint without the use of a separation cord



Fig. 25 – Section of a structural joint with a separation cord

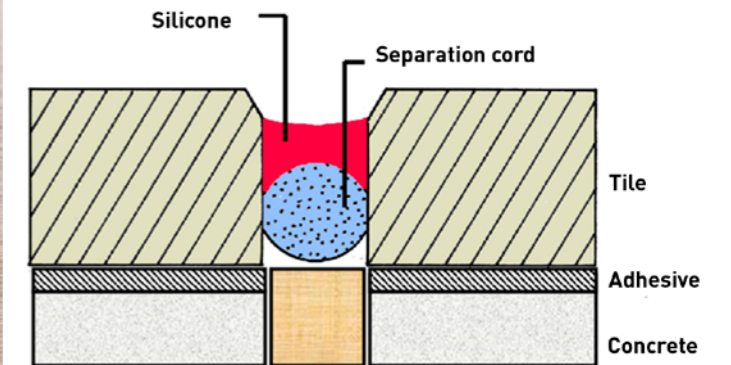
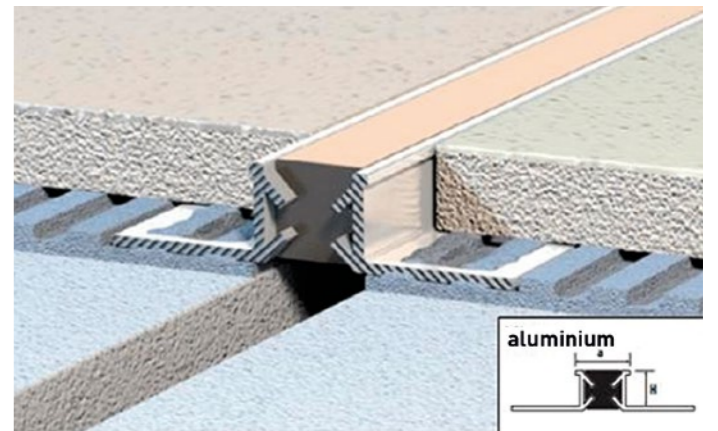

Fig. 27 Flexible expansion joint strip



Requirements for minimum width of expansion joints according to CSN 73 3451	
Perimeter joints	5 mm
Intermediate joints	5 mm
Construction joints	the width of the laying joint corresponds to the joint of the structure
Recommended minimum widths of expansion joints according to CSN 73 3451-1 (not structural)	
Wall / Interior	3–5 mm; max. aspect ratio 1:2
Wall / Exterior	8 mm; max. aspect ratio 1:3
Floor / Interior	5 mm; max. aspect ratio 1:3
Floor / Floor heating	5 mm; max. aspect ratio 1:2
Floor /Exterior	8 mm; max. aspect ratio 1:3
Construction joints	the width of the laying joint corresponds to the joint of the structure
Requirements for maximum side lengths of the expansion field according to CSN 74 4505	
Interior	6 m; max. aspect ratio 1:1.5
Exterior & interior with floor heating	3 m; max. aspect ratio 1:1.5
Recommended maximum lengths of the side of the expansion field according to CSN 73 3451-1	
Interior	6–7.5 m
Interior with floor heating	3–4 m
Exterior	2.5–3.6 m

7. CONTACT LAYING PROCEDURES

7.1 WATERPROOFING THE SHOWER ENCLOSURE

1/ Application of waterproofing to the shower enclosure floor substrate

Waterproofing coatings and screeds prevent moisture from penetrating into the shower enclosure substructure. In the case of a shower enclosure with a trough, apply the first layer of waterproofing screed RAKO SYSTEM SE6 to the substrate and waterproofing tape RAKO SYSTEM SE5 to the transition points (wall/floor and breaks). The



continuous and high water load on the shower enclosure floor.

3/ Waterproofing the wall trough

Less common is the waterproofing of the wall trough. In the corner of the shower enclosure, we spread MS polymer, which features high adhesion, strength, and flexibility, on and around the trough surface. We then press the manufacturer's waterproofing tapes into the sealant, which are waterproofed with RAKO SYSTEM SE6 waterproofing screed. As an option, we can also use RAKO



application of the tape will prevent cracks from forming in the corners and fractures of the shower enclosure.

2/ Inserting the sleeve around the floor drain

Press the floor drain manufacturer's sleeve around the collar of the drain into the freshly applied first layer of waterproofing and wait 20 hours for it to dry. Then we cover the drain with a protective cap to protect it from dirt as we work. Cover the sleeve, tapes, and the entire shower enclosure area with a second coat of waterproofing screed. RAKO SYSTEM SE6 waterproofing can easily handle the



SYSTEM SAB polyurethane sealant and RAKO SYSTEM SE5 waterproofing tapes to fix the tapes.

4/ Laying around the trough

We use RAKO SYSTEM AD530 flexible adhesive on heat-stressed areas such as the shower enclosure and apply it in one direction with a 10-12 mm tooth trowel. To achieve complete coverage of the tiles with the adhesive, we apply the adhesive in one direction and on the reverse of the tiles with a tooth of 4-6 mm and lay the tiles in the same



direction as the adhesive is applied to the floor. We use wedges and crosses to define the joints around the trough.

5/ Waterproofing around water inlets

The space between the water inlet and the wall (wall board) is one of the critical areas of the laying. First, spread the first coat of RAKO SYSTEM SE1 waterproofing coating evenly on the wall substrate, which is suitable for less water-loaded areas. Seal the gap between the substrate and the water inlet with RAKO SYSTEM SAB polyurethane sealant. The waterproofing should cover the shower enclosure wall to the height of at least 30 cm above the shower head. For shower enclosures without a shower head, the waterproofing should extend to the height of at least 2 m above the floor. In the adjacent areas of the



bathroom, apply waterproofing on the floor, under the bath tubs and on plinths up to the height of 10 cm.

6/ Waterproofing around water inlets

Pull and push the RAKO SYSTEM SE5 sleeves over the water inlets into the freshly applied first coat of waterproofing. Do not forget to squeeze out any remaining air. After the first layer has dried (24 hours), cover the sleeves and the entire shower enclosure area with the second layer of waterproofing RAKO SYSTEM SE1. Use the sleeve to precisely seal the wall with the penetrations.



Video instructions are also available at www.rako.eu, in the sections Tips and Considerations before Laying.



7.2 SHOWER ENCLOSURE SEALING

1/ Inserting the PES separation rope

Cracks and crevices in the joint can allow moisture to enter the shower enclosure substrate. We, therefore, pay particular attention to sealing joints at critical transitions between the wall and floor, between walls, and at connections between tiles and the trough or tray. First of all, before grouting, we insert the RAKO SYSTEM PES separating rope into the transition (expansion) joints. This will reduce the risk of cracking and tearing of the flexible sealant from the ceramic tiles in the joint. To prevent the rope from falling through the joint, it should be 50 % larger in diameter than the joint width.

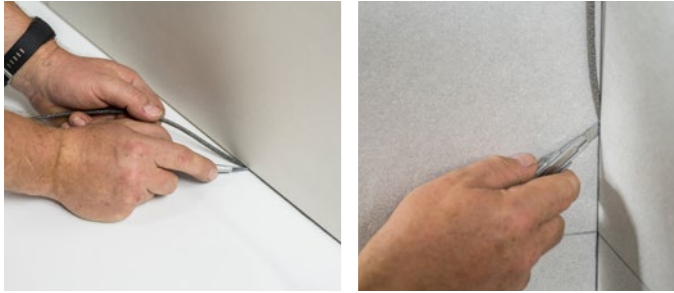

2/ PRIMER application

Next, apply RAKO SYSTEM PRIMER to the joint with a brush to increase the adhesion of the silicone sealants to the tiles.



3/ Application of RAKO SYSTEM ASI silicone sealant in corners and high stress joints

We then apply RAKO SYSTEM ASI flexible silicone sealant evenly to the corners and joints and seal the joint around the shower trough in the same way. The use of conventional cement grout to form expansion joints is inappropriate. Transitions between metal and ceramic materials tend to be prone to crack formation because these materials feature completely different thermal expansion rates.



4/ Expansion joint forming

The smoothing solution RAKO SYSTEM CL807 helps better shape and smooth the expansion joint. After its application, remove the excess sealant with an elastic trowel and shape the joint into a rounded profile. Unlike the soapy water used, the solution allows the additional silicone to adhere seamlessly to the original sealant layer.



5/ Sealing shower enclosures without a tray

In the case of shower enclosures without a shower tray, we again insert the RAKO SYSTEM PES separating rope into the inner corners of the floor section. By applying RAKO SYSTEM SAB polyurethane sealant, due to its high adhesion, we reduce the risk of cracks in the joints to the minimum. It adheres well to both metal and tiling. It is suitable for the most stressed areas of the shower enclosure.



6/ Water drainage

For smooth water drainage and to reduce water retention on the shower enclosure floor, a slope of at least 1.5 % is required. Retained water increases the risk of leakage into the substrate, but also leaves more dirt on the ceramic tiling.



7/ Sealing common inelastic joints

For normal grouting, use the flexible cement grout RAKO SYSTEM GFDRY with reduced absorption, or the extra mould- and bacteria-resistant RAKO SYSTEM GFBIO grout. Mix the grout thoroughly according to the instructions and leave to stand. This will reduce the amount of air bubbles in the compound that can cause leakage into the substrate. The life of the grouting can then be increased by using RAKO SYSTEM GEASY, a two-component epoxy grout with high mechanical and chemical resistance.



8/ Sealing shower enclosures with a tray

When installing a tray in a shower enclosure, apply RAKO SYSTEM SAB polyurethane sealant to the perimeter and under the tray. Polyurethane is not only more adhesive than silicone sealants, but also more flexible.



9/ Inserting the tray under the tiling

Insert the tray under the tiling to reduce the risk of leakage under the tray. Conversely, placing the tray against the tiling is much more prone to cracks forming between the tiling and tray. Trays and bath tubs are springy and thus make high demands on the flexible expansion joints between them and the ceramic tiles.



10/ Inserting the RAKO SYSTEM PES rope between the tray and tiling and joint shaping

Before sealing the expansion joint with RAKO SYSTEM ASI silicone sealant, insert the RAKO SYSTEM PES separating rope again into the cavity between the tray and ceramic tiling. After the application of RAKO SYSTEM CL807, the excess silicone is again removed with a trowel.



11/ Sealing the space between the water inlet and tiling (wall) and joint sealing

For heat-stressed areas such as the space between the water inlet and tiling (wall), use RAKO SYSTEM SAB polyurethane sealant for sealing, which has excellent adhesion. As it is very adhesive, we are careful not to get the tiling dirty. The RAKO SYSTEM CL807 smoothing solution will help us better shape the flexible sealant in the joint.



12/ Sealing the screen moulding with silicone and silicone tape

We seal the screen moulding to the ceramic tiles from the inside with RAKO SYSTEM NSI transparent silicone sealant, which is gentle on metal profiles and glass and does not leave marks on their surface. On the outside, we then use silicone tape from the shower enclosure manufacturer to seal the screen.



8. DRY TILE-LAYING TECHNIQUE

The following methods for the dry tile-laying technique are used: laying into lawns, laying into gravel, and laying on pedestals. The laying of ceramic tiles into gravel and lawns has the same solution of the base. The use of gravel (crushed aggregate) which, unlike sand, does not absorb water or expand during frost. The laying of ceramic tiles on pedestals is based on the use of a system of supports, or so-called "pedestals".

For the solution of dry laying, we use RAKO OUTDOOR vitrified floor tiles with a thickness of 2 or 3 cm. These tiles are frost-resistant; therefore, they can withstand external loads with practically no limitation. Unlike concrete floor tiles, they are not absorbent, and can therefore be easily cleaned. When using these tiles, their breaking resistance and weight are decisive parameters. Thanks to digital printing technology, the quality and design of these tiles are indistinguishable from natural materials that they faithfully imitate. Specifically, we can offer a unique design of stone and wood in the QUARZIT, KAAMOS, PIAZZETTA, REBEL series and in the NEWS 2024 series BETONICO, BRICOLA, CASTONE and VALS.

8.1 LAYING INTO LAWNS AND GRAVEL

Laying into lawns

Durable solution of areas of gardens, garden paths, or pergolas intended as a final walking floor surface, see Fig. 32. When laying ceramic tiles into lawns, we use gravel (crushed aggregate), which, unlike sand, does not absorb water or expand during frost. A gravel layer with a size of 4–8 mm should reach a height of 50 mm. RAKO OUTDOOR floor tiles with a thickness of 2 cm, but their movement is bordered with the surrounding soil and gravel, and seamlessly connects to lawns or pebbles in space.

Laying into gravel

Environmentally-friendly solution of areas intended as final walking floor surfaces of terraces, pavements, pergolas, or parking spaces, see Fig. 32. Thanks to the permeable base, water is returned into the subsoil and not removed from the landscape through drains and sewers. Before laying, remove the soil. The bottom of the trench should have the required slope of 2% from the facility, and base layers should have the same thickness at all points of the surface. The laying of floor tiles should copy the required slope of 2% so that water and dirt are better drained from the surface. The following two types of laying are used: laying on surfaces intended as final walking surfaces, or laying on surfaces under load of vehicles.

In case of laying on surfaces intended as final walking surfaces, apply coarse gravel with a size of 8–16 mm and thickness of 200 mm on a compacted soil, and compact this layer again with a vibrating device. In the second layer, apply finer gravel with a size of 4–8 mm and a thickness of 50 mm, spread it evenly in the required slope gradient, but no additional compaction is required, see Fig. 28. Place the RAKO OUTDOOR tiles with a thickness of 2 cm into a gravel bed, and fix them in place using a rubber mallet or a special trowel with rubber. To ensure regular joints between the tiles, use small crosses with a width of 3–4 mm for outdoor use, see Fig. 29. Joints between the tiles ensure effective water drainage from the surface, and evaporation of moisture from the base. Decorate the edges with pebbles or grass, or you can use concrete curb stones too.

For surfaces under the load of vehicles, apply coarse gravel with a size of 16–32 mm and a thickness of 200 mm on the compacted soil, and compact this layer again. In the second layer, apply finer gravel with a size of 8–16 mm and a thickness of 50 mm, spread it evenly, and compact this layer. In the third layer, apply gravel with a size of 4–8 mm and a thickness of 50 mm, spread it evenly, but no additional compaction is required. Place the RAKO OUTDOOR tiles with a thickness of 3 cm into a gravel bed, and fix them in place using a rubber mallet or a special trowel with rubber. To ensure regular joints between the tiles, use small crosses with a width of 3–4 mm for outdoor use. Joints between the tiles ensure effective water drainage from the surface, and evaporation of moisture from the base. Decorate the edges with concrete curb stones. Finishing with curb stones reduces the risk of horizontal movement of the tiles when the surfaces are subject to vehicles driving over, see Fig. 30. The joints between the tiles can be filled with fine silica sand or a mixture of silica sand and resin, which prevents the joints from being washed out.

You can find other contact laying system solutions (Pool, Balcony, Silence Tiles, etc.) in the RAKO SYSTEM catalogue or on our website www.rako.eu.

For public pavements and roads, the requirements of CSN 73 6133, Road earthwork – design and execution, should be followed.

Fig. 28, 29, and 30 – Laying into gravel



8.2 LAYING ON PEDESTALS

Laying on pedestals

Laying on pedestals is a dry laying technique, based on the use of a system of supports, the so-called pedestals for terraces, balconies, roofs or public areas, offering an easy access to cabling, water drainage or the hydro-insulation during operation, see Fig. 28. The supporting base is mostly a concrete slab that should have an inclination of 2 % from the object. Before the installation of the pedestals, we first cover the concrete with a hydro-insulation layer. Most commonly, a hydro-insulation PVC foil with a reinforced grating is used (min. thickness 1.5 mm). Less common, but high-quality are modified SBS asphalt stripes with reinforcing grating (min. thickness 4 mm) or final surface hydro-insulation coatings, e.g. RAKO SYSTEM SE2.

It resists sulphates (acid rain), chlorides (cleaning), CO₂ penetration, and is frost-resistant. Underlay the PVC sheet with a geotextile to reduce the risk of the sheet being punctured by sharp tips on the concrete surface. For smooth concrete, we use thin geotextile 1.5 mm thick and for rough surfaces, we use thicker 3 mm grammage material. The PVC foil should be no thinner than 1.2 mm and should overlap by 20 cm during welding. A poorly made hydro-insulation under the pedestals is commonly the weakest part of the laying process.

In case of pedestals, we can either choose adjustable (screwing) or fixed pedestals (layered onto each other). Thanks to adjustable pedestals, we can level-out e.g. slanting terraces into horizontal surfaces. We do not recommend horizontal laying for pedestals with fixed height. The levelling of the slope is difficult and the tiling is not stable. For tiling on pedestals, we use the RAKO OUTDOOR tiles with the thickness of 2 cm, where the crucial factors are the break resistance and the tile weight that has a key influence on the stability of the tiling (1 tile weights 16 kg). Laying on pedestals is not intended for being loaded with cars, it is only suitable for walking traffic.

For the 60 × 60 cm tile format, we place the pedestals only under the corners of the tiles, so that they support the adjacent tiles at the same time. It is not necessary to insert the pedestals under the centres of the tiles with this format. Laying on pedestals cannot handle the load of vehicle traffic and is only suitable for pedestrian traffic. In the case of a staircase laid on pedestals, we can follow the technical drawing below. For greater safety of movement on the ceramic tiles, we recommend that the pedestals are fitted with rubber pads at the bottom and top and bonded to the substrate and tiles with RAKO SYSTEM SAB polyurethane sealant or MS polymer.

Some producers offer special discs that fix with a screw to the pedestal, see picture. They prevent the tiles from moving on the edges of the balconies and prevent the tiles from being lifted by the wind gusts of high-rise buildings.

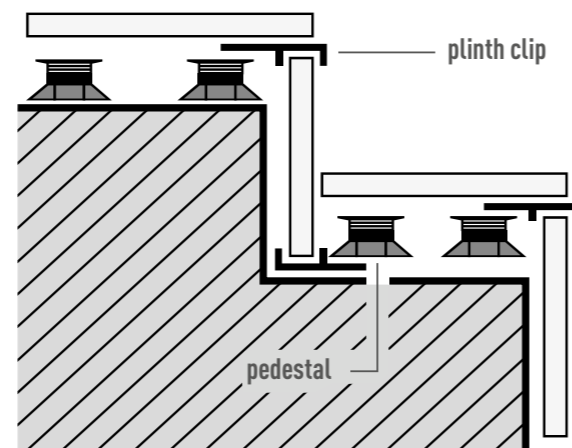

Pedestals and beams

The market offers a number of rubber or polypropylene pedestals at heights ranging from 0.5 to 100 cm. In the manufacturers' materials we can then find if the pedestals are frost-resistant and resistant to breakage. They are height adjustable, or with a fixed height. In the case of adjustable pedestals, the slope of terraces and balconies can be adjusted in two ways: by using swinging pedestal heads, or by placing slope correctors under the pedestals. The load capacity of supports ranges from 650 kg to 1200 kg. On the pedestal heads, there are rubber washers with spacers to ensure regular joints between tiles in the range of 3-4 mm. The joints should not be below 3 mm. Flexible pads are placed under the pedestals or slope correctors to reduce the risk of horizontal movement of the tiles, see Fig. 31.

Fig. 31



Fig. 32

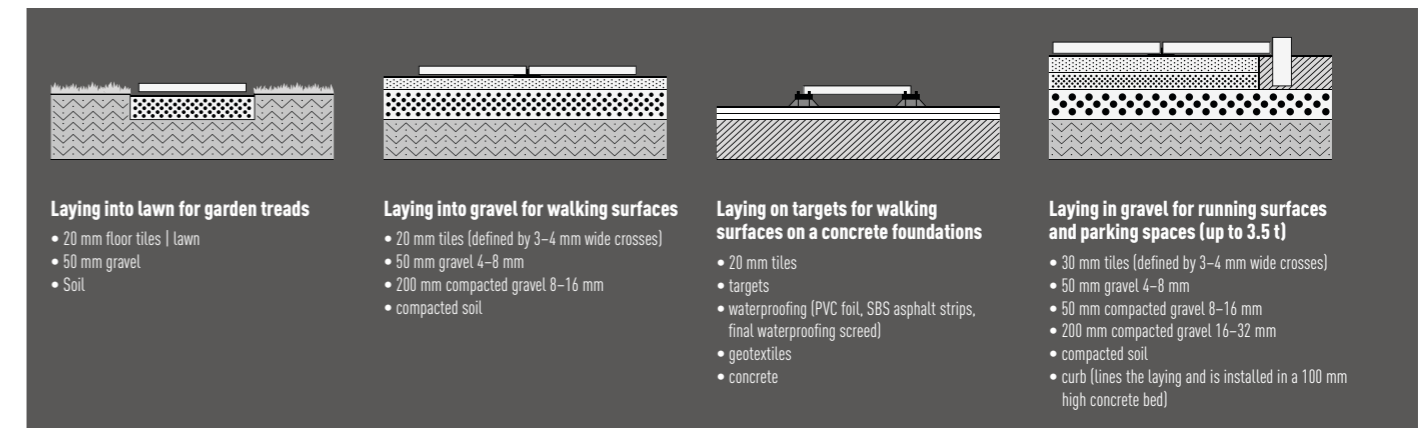

8.3 PROCEDURES FOR DRY LAYING

1/ Preparation: You will need coarse gravel with a size of 8–16 mm, finer gravel with a size of 4–8 mm, pebbles, small crosses for outdoor use with a width of 3–4 mm, a rubber mallet, spirit level, smoothing beam, and RAKO OUTDOOR tiles with a thickness of 2 cm.



2/ First sub-base layer: Remove the soil under the tiles to a depth of 20 cm, with a slope of 2 % from the facility, and compact the soil with a vibrating device. Apply gravel with a size of 8–16 mm to a height of 20 cm, and compact it again.



3/ Second sub-base layer: In the second layer, apply finer gravel with a size of 4–8 mm to a height of approximately 4–5 cm. The gravel layers should have the same height.



4/ Base preparation: Spread the gravel evenly with a smoothing beam, but no additional compaction is required.



5/ Tile placement: Place the tiles into gravel and fix them in place with a rubber mallet at a slope of 2 % from the facility.



6/ Ensuring regular joints between the tiles: Place small crosses for outdoor use with a width of 3–4 mm into the corners. This will ensure continuous water drainage and evaporation of moisture from the base.



7/ Surface: In this manner, lay gradually the tiles on the entire surface, and continuously check the flatness of the tiles using a spirit level. Fix the surface with a rubber mallet, or apply fine gravel to correct the sunken areas, as required.



8/ Bordering: Finally, decorate the edges of the tiled surface with pebbles, or grass. You can also use fine silica sand to fill joints.



Video instructions are also available at www.rako.eu, in the sections Tips and Considerations before Laying.



Laying of RAKO OUTDOOR floor tiles into gravel for final walking surfaces

1/ Preparation: The laying on adjustable pedestals is a method of tile laying with a thickness of 2 cm and the use of adjustable supports, or so-called "pedestals". Prepare the required number of pedestals, including slope correctors and spacers, rubber washers, stops or skirting clips, RAKO OUTDOOR ceramic tiles with a thickness of 2 cm, a spirit level, and a cutter. PVC waterproofing foil with reinforcing grids (min. thickness of 1.5 mm) is recommended as a base. To reduce the risk of foil puncture, use PVC foil and underlay it with geotextiles. The concrete base plate should have a slope of 2 % from the facility. Installation of the foil should be performed by a professional worker.



3/ Pedestal height adjustment: Place the pedestal into the slope corrector. Adjust the required height of the pedestals by turning according to the determining height of the pedestal at the highest point of the terrace, or balcony.

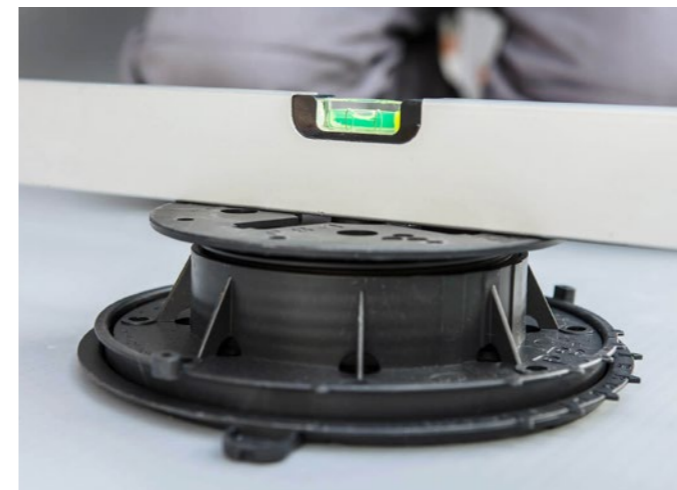

2/ Slope adjustment: By turning the slope corrector, adjust the horizontal base under the pedestals. In this manner, the slope of the base is adjusted up to 5 %. As the inclination angle and the direction of slope always differ, each pedestal must be adjusted individually. The supports equipped with telescopic swinging heads are levelled automatically up to a slope of 10 %.



4/ Placement of spacers: Place the dilatation spacers on the pedestals, and adjust the number of dilatation spacers by cutting, or breaking out as needed. The spacers define the joint width, which is necessary for water drainage and evaporation. It is recommended to select the space width of 3 mm as a minimum.

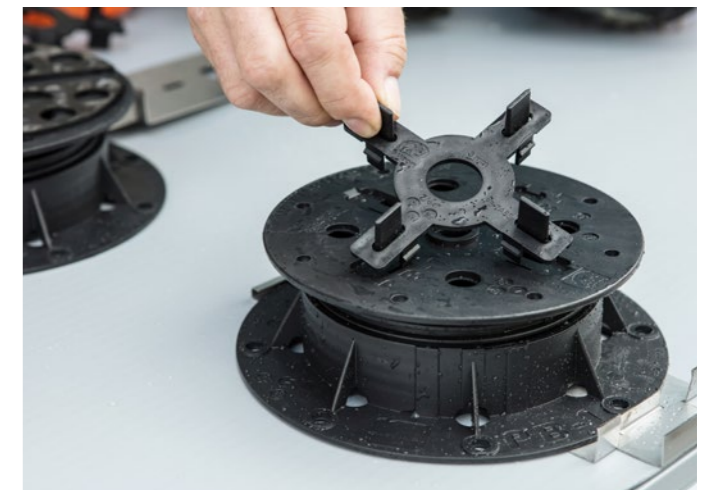

5/ Creating the leading edge of the balcony, or terrace:

If there is not a solid edge around the tiles, such as skirting, wall, etc., use the skirting clips to form the leading edge, and place these clips on the head of the pedestals and under them.



6/ Placing the rubber pads on pedestals:

Due to the spring and settling action of laid tiles, place rubber pads on the pedestals.

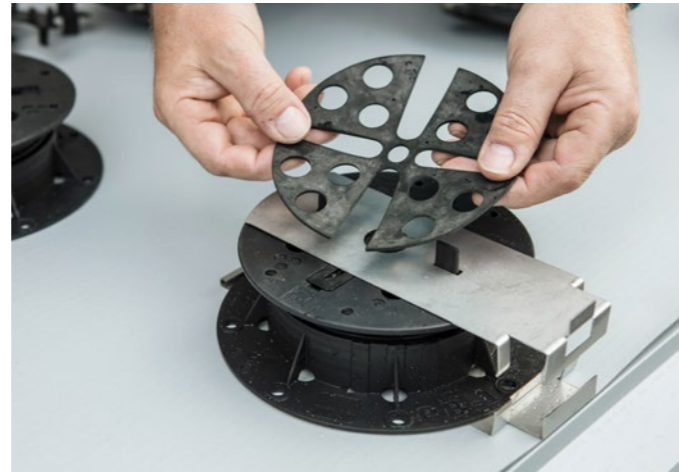

7/ Ensuring the regular distance between the pedestals:

Before laying, check the distance between the pedestals to a tile format of 60 x 60 cm.

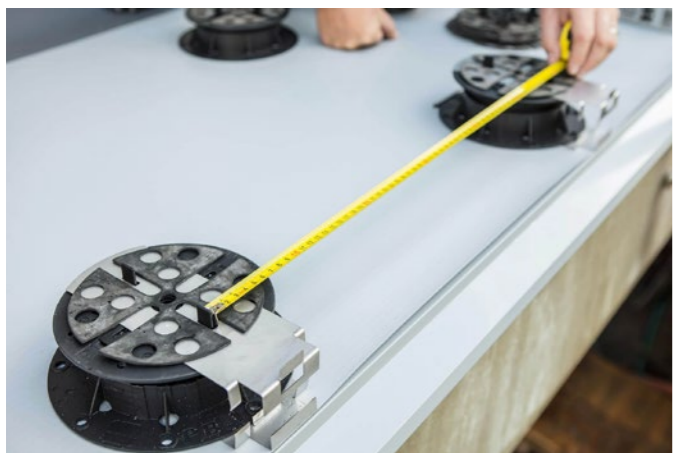

8/ Laying of tiles:

Lace a tile on the pedestals. Handling a 16 kg tile is more difficult than handling tiles of common thickness. After laying, check whether the tile is laid horizontally.



9/ Cutting tiles with a thickness of 2 or 3 cm:

Only electric cutters with guide rails, or water-cooled stand saws, are able to cut embossed tiles with a thickness of 2 cm.



10/ Inserting strips into skirting clips:

Insert the cut and ground ceramic strips into the skirting clips, and create the leading edge of the balcony, or terrace.



11/ Finishing the leading edge with a water bar:

The finished ceramic leading edge of the balcony seamlessly connects to the finishing profile with a water bar.



12/ Inserting stops between the wall and tiles:

Measure individual finish cuttings to the door and balcony wall. To define laying, the stops are used between the balcony wall and tiles. These stops prevent the PVC foil from being cut through the edge of the tile adjacent to the wall.

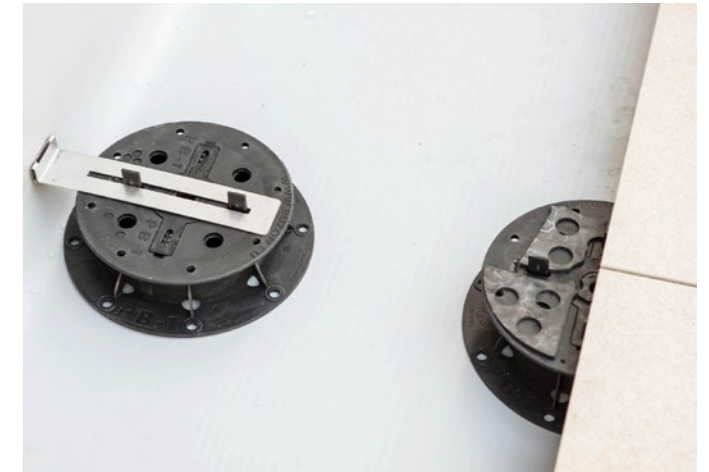

13/ Final laying:

The laying on pedestals is suitable for terraces, balconies, roofs, or public spaces with trouble-free access to drains or waterproofing. The laying on pedestals is not intended for surfaces subject to vehicles driving over them.



Video instructions are also available at www.rako.eu, in the sections Tips and Considerations before Laying.



Laying of RAKO OUTDOOR floor tiles on pedestals with a fixed height

1/ Preparation:

The laying on pedestals with a fixed height is a system using supports (pedestals) and floor tiles with a thickness of 2 cm which can withstand the load caused by walking. Prepare the required number of supports, a cutting knife, RAKO OUTDOOR ceramic tiles with a thickness of 2 cm, a spirit level, and a cutter. PVC waterproofing foil with reinforcing grids (min. thickness of 1.5 mm) is recommended as a base. To reduce the risk of foil puncture, use PVC foil and underlay it with geotextiles. The concrete base plate should have a slope of 2 % from the facility. The installation of the foil should be performed by a professional worker. If the technological procedure is not followed, there is a risk of water intake into the structure.



2/ Adjustment of pedestals:

Adjust the pedestals, cut off the excess parts of the pedestals, spacers, which will not be needed at the wall or in the corners of laying.



3/ Laying of pedestals:

Start with the pedestals on the outer edge of the balcony. Before laying the tiles, check the distance between the pedestals to a tile format of 60 x 60 cm.



4/ Tile placement:

Place the tiles so that the supports with a fixed height support tile corners.



5/ Surface:

Check the flatness of the surface with a spirit level. The spacers define the joint width, which is necessary for water drainage and evaporation.



6/ Measurement of finish cuttings:

Measure exactly the dimensions of individual finish cuttings to the door and the balcony wall.



7/ Location of finish cuttings in the corner:

Insert the adjusted pedestal into the corner, and install the cut-out tile to its place.



8/ Connection of cut tiles:

The cut ceramic tiles seamlessly connect to the door and the balcony wall.



9/ Finishing the balcony and terrace with metal profiles, or water bars:

Edges of the balcony can be finished with metal profiles, or bars. The laying on pedestals is suitable for terraces, balconies, roofs or public spaces with trouble-free access to drains, or waterproofing systems. The laying on pedestals is not intended for surfaces subject to vehicles driving over them. Video instructions are also available at www.rako.eu, in the section Tips and Considerations before Laying.



Video instructions are also available at www.rako.eu, in the sections Tips and Considerations before Laying.



9. INSPECTION OF THE INSTALLATION AFTER LAYING

A visual inspection of the installation is carried out from a distance of at least 1.5m in interiors, or 2.5m in exteriors, from the wall/floor at eye level, and under normal lighting. It is not permitted to use halogen lights, or lighting at an oblique angle. Details of the laid tiles (joints, etc.) are checked from a maximum distance of 0.6m.

Fig. 33

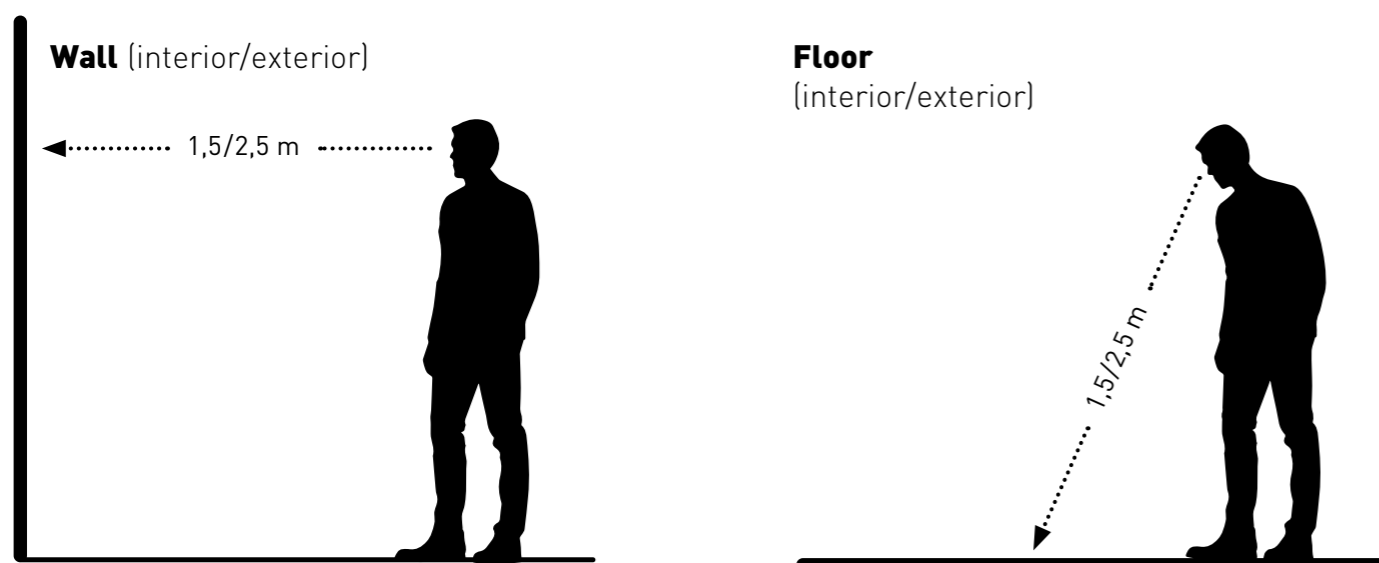
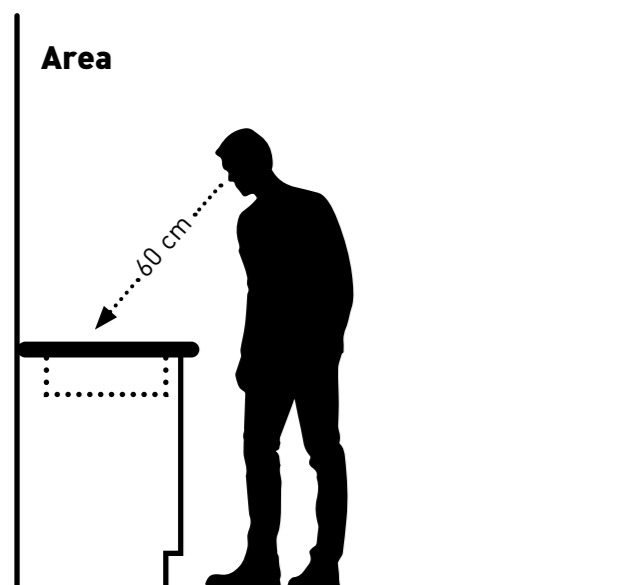

Fig. 34



10. MAINTENANCE AND CLEANING OF CERAMIC WALL AND FLOOR TILES

Maintenance and cleaning of ceramic wall and floor tiles

Regular and correct cleaning is an integral part of wall and floor tile care. Cleaning technique and products must be selected correctly, depending on the nature of soiling, type of surface, and cleaning method. The following types of cleaning of ceramic materials must be taken into account:

Post-building-work cleaning – cleaning after the building work completion.

Regular cleaning – routine periodic cleaning.

Heavy duty cleaning – carried out 1–2 times a year.

Depending on the size and type of the surface to be cleaned, the cleaning can be performed either by hand using a brush, cloth, pad or mop or, for cleaning large surfaces, suitable rotating cleaning machines or vacuum cleaners, or high-pressure cleaning machines can be used. High-pressure cleaning machines with a spraying injector are suitable for severely soiled and anti-slip surfaces. Irrespective of the used cleaning technique, it is necessary to make sure that the released dirt dissolved during the cleaning process is removed, and not allowed to dry again. Using a high-performance water vacuum cleaner is the most gentle and reliable method of removing dirt. After cleaning, the surface should remain dry.

Post-building-work cleaning – cleaning after building work completion

After tiles have been laid, the tiled surface must be cleaned of sediments and materials left from building work and cement grouting. Detergents containing acids (pH < 3), so called cement residue removals, are the best means for this purpose. We recommend **RAKO SYSTEM CL802**. For this type of cleaning, the detergent must be appropriately diluted to prevent dark and highly pigmented grouting materials from being disturbed and bleached. For wall tiles – in group BIII – the **RAKO SYSTEM CL802** product can be diluted in 10l of water. For floor tiles and vitrified floor tiles – in group BIa – 100–200 ml of the **RAKO SYSTEM CL802** product can be diluted in 10l of water. First, the surface must always be thoroughly soaked with water, and neutralised again with water after cleaning!

Stains of penetration, paint, varnish, silicon, or epoxy must be removed using special cleaning products, or the **RAKO SYSTEM CL810** concentrate. To remove epoxy residues from ceramic tiles, use the **RAKO SYSTEM CL805** epoxy sealant removal agent, which can be applied immediately after placing the epoxy into the joint.

Regular cleaning – routine periodic cleaning

Routine maintenance and cleaning of all types of tiles is performed by sweeping, vacuum cleaning, or wiping the surface with a wet cloth or mop, using a suitable neutral detergent (pH 6.0 to 8.0); here we recommend **RAKO SYSTEM CL803**, for all types of wall and floor tiles at areas with a low amount of traffic (flats, family houses, offices) and with a high amount of traffic (shops, halls, hallways, apartment buildings...) **RAKO SYSTEM CL801** is recommended.

Heavy duty cleaning – thorough cleaning, carried out 1–2 times a year

It is used to remove heavily soiled surfaces created during the use of compact tiles and vitrified tiles in the BIa group, which could not be removed by regular cleaning. Alkaline detergents (pH > 8) are most frequently used for removing greasy residues (organic dirt) deposited on floor tiles; we recommend **RAKO SYSTEM CL810**, and for removing lime sediments caused by hard water (inorganic dirt), acidic detergents (pH < 6), such as **RAKO SYSTEM CL801**, are recommended. In combination of these agents, you can also remove heavily soiled tiles.

To clean heavily soiled surfaces, containing fatty deposits on wall tiles in group BIII, alkaline cleaners (pH > 8) are used; we recommend using the **RAKO SYSTEM CL810** product, and dilution recommended by the manufacturer. To remove lime scale deposits caused by hard water on wall tiles in group BIII, alkaline cleaners (pH < 6), such as **RAKO SYSTEM CL801**, are recommended. Before the use of acidic detergents, moisten the tile surface, and, after application of diluted **RAKO SYSTEM CL801** (40–100 ml in 10l of water), rinse the tile surface several times with clean water.

Do not use cleaning agents containing hydrofluoric acid for the maintenance of wall and floor tiles, because ceramic tiles are massively distorted and permanently damaged after short-term exposure!

Never use non-recommended detergents which can create a thin layer on the tile surface that may reduce anti-slip properties of ceramic floor tiles, damage the glazing, or optically change the surface, create smudges, and impair cleanability. Always closely follow instructions of the detergent manufacturer in respect of application and dosing, since incorrect application can disturb and damage the ceramic surface and elastic sealing materials.

Special cleaning procedures:

- **Decorative products decorated with golden, platinum, and mother-of-pearl surfaces** must be cleaned with the **RAKO SYSTEM CL803** detergent. Never use detergents and tools containing abrasive particles, or corrosive chemicals for cleaning these products.

- **Metallic surface finishes**, e.g. the Defile (brown) series, have a thin surface layer containing metal, and these require extra care when being cleaned. To reduce residues of the grouting material and dirt stains, we recommend wetting the grouting with water, degreasing the tiles with a diluted **RAKO SYSTEM CL810** detergent (40–100ml in 10l of water), neutralising them with water, cleaning them with the **RAKO SYSTEM CL801** solution (40–100ml in 10l of water), and rinsing with clean water again. The combination of the two detergents can then be alternated to achieve a perfect cleaning result. We do not recommend applying impregnation coatings on metallic surfaces, or using not verified detergents.
- **Anti-slip floors must be cleaned regularly using recommended detergents**, depending on the nature of soiling. Any dirt, sand, greasy deposits, or remnants of snow and ice significantly reduce the anti-slip properties of the floor tile surface. For greasy patches, we recommend using the **RAKO SYSTEM CL810** alkali detergent in the above specified concentration. The floor must be thoroughly rinsed with plenty of clean water before and after the use of acidic and alkali detergents. For cleaning larger areas, we recommended using cleaning machines, either with gentle mechanical cleaning mechanisms, or with water under pressure. For removing water from the surface of anti-slip floor tiles, e.g. on walkways around swimming pools, or floors in large kitchens, we recommend using special tools (e.g. window rubber blades). Applying the **RAKO SYSTEM CL809** impregnation products makes the maintenance of smooth and anti-slip floor tiles easier.
- **Floor tiles treated with the RAKO SYSTEM CL809 impregnation product** are easier to maintain, and require less detergent (lower concentration). It is always necessary to use this product on polished, vitrified, unglazed tiles TAURUS immediately after laying and cleaning, because polishing technology reduces the resistance to staining. For regular maintenance of floor tiles treated in this manner, a solution of the **RAKO SYSTEM CL803** detergent with water (see above) will be sufficient.

Cleaning procedures

When cleaning standard ceramic surfaces, please follow these procedures:

Type of cleaning	Process	Cleaning agents and dilution
Post-construction cleaning – cleaning of loose dirt	Sweeping or vacuuming	
Post-construction cleaning – cleaning of cement residues, mineral, calcium and magnesium deposits, cement bloom, paint rock, rust	<ol style="list-style-type: none"> 1. Ceramic tiles and joints should be completely wet (use sufficient quantity of clean water) 2. Apply the cleaning solution, leave for 10 to 15 min. then clean with microfiber mop, pad or nylon brush or sponge 3. Remove dissolved dirt 4. Mop the tiles up twice with sufficient quantity of water 	e.g. RAKO SYSTEM CL802 - dosage: 50 to 100 ml per 10 l of water for tiles of group BIII; 100 to 200 ml per 10 l of water for tiles of group Bla.
Removal of fats, oils, waxes, cosmetics and abrasions of from shoes	<ol style="list-style-type: none"> 1. Apply the cleaning solution, let act leave for 10 to 15 min and clean with microfiber mop, pad or nylon brush or sponge 2. Remove dissolved dirt 3. Wash the tiles thoroughly with water afterwards 	e.g. RAKO SYSTEM CL810 in dosage: 40 to 100 ml per 10 l of water.
Regular cleaning – removal of normal soiling, such as dust, slightly sticky dirt, dirt from the street	Apply the cleaning solution, and clean with mop, pad, nylon brush or cloth	e.g. RAKO SYSTEM CL803 - heavily loaded areas RAKO SYSTEM CL801 , dosage: 20 to 100 ml per 10 l of water. Bathrooms, toilets - RAKO SYSTEM CL804 (direct spray).
General cleaning - acidic environment (mineral impurities: residues of cement, lime, calcium soaps, rust, scale, urines)	<ol style="list-style-type: none"> 1. First, soak the tiles (joints)! 2. Apply the cleaning solution (concentrated solution may be used on stains) and clean using a mop with microfibers, a pad, or a cleaning machine 	for cleaning inorganic impurities use RAKO SYSTEM CL801 , dosage: 40 to 100 ml per 10 l of water; for cleaning organic impurities, use
General cleaning - alkaline environment (contaminated with grease or oil)	<ol style="list-style-type: none"> 3. Remove the dissolved dirt by suction 4. Wash the tiles again thoroughly with water 	RAKO SYSTEM CL810 , dosage: 40 to 100 ml per 10 l of water.

11. SHOPPING TIPS AND CONSIDERATION BEFORE LAYING

What are the advantages of ceramic tiles?

- Ceramic tiles are hardy and have no limits either indoors or outdoors
- Ceramic tiles have a higher abrasion resistance compared to natural stone and
- better thermal conductors and heat accumulators than laminates and vinyl
- Ceramic tiles do not shrink over time, which reduces the risk of leakage into the substrate
- They are hygienic and highly resistant to chemicals,
- highest fire resistance and
- higher UV resistant
- They do not weigh as much as concrete tiles and, therefore, the construction is lighter
- They do not pollute the natural environment and can be recycled

How to select ceramic tiles?

When selecting ceramic tiles we should consider their functional characteristics in addition to their aesthetic aspect. This means taking into account the environment, in which the products will be placed and how they will be used. Wall tiles are only suitable for internal walls. Ceramic tiles are hardy and can therefore be used both indoors and outdoors. You can also use them on the wall and on the floor without any problems. When selecting products check whether they are hard enough and suitable for the floor according to the symbols indicated by the manufacturer.

Are the tiles wear-resistant?

- Unlike other materials tiles are not at risk of being scratched by pets or children's toys, nor are they scuffed when moving furniture. A ceramic tile is comprised of a very hard material that reaches 7 on the Mohs hardness scale. This is roughly the double of some natural stones, such as travertine or marble.
- For glazed tiles we monitor the abrasion resistance value. The higher the degree of abrasion resistance, the greater the operational load the tiles can withstand. For apartments and private housing, an abrasion resistance rating of PEI 3 is sufficient. For demanding environments, such as offices or shopping centres, we recommend products with the highest abrasion resistance rating of PEI 4 or PEI 5. Most RAKO glazed tiles feature these values.
- For unglazed tiles, which are suitable for the most demanding areas in terms of wear, the required abrasiveness value is important. RAKOs unglazed tiles fulfil this requirement.

Why is the slip resistance of the surface important?

- The slip resistance of the surface is related to the safe movement of people both in shoes and barefoot. If you choose the right slip resistance tile surface, the tiles will not even be slippery when wet. Wet indoor floors and outdoor areas on terraces and around swimming pools present the most difficult challenge in ensuring slip resistance.
- On the basis of practice and national standards, we recommend using a slip-resistant surface of class R10 for walking in shoes and class B for barefoot walking for wet floors in the interior. ABS surfaces not only meet this slip resistance requirement but are also very easy to clean. For exteriors we recommend using tiles with a slip-resistant surface of class R11/B. It's obvious that slip-resistant surfaces require extra care in maintenance, including the use of professional cleaning products.

How to correctly calculate the ceramic tiles needed for the project?

- Manually counting the required pieces or cartons of ceramic tiles is challenging. Not all of us have a good eye for spatial visualisation. Fortunately, there are visualisation programs available for ceramic material sellers who will be happy to offer you a visualisation service.
- Based on the given dimensions of the project, the visualisations simulate its future form. They include among other things, tiling plans (pattern drawing) and piece lists (material breakdown). This will provide you with the final required quantity of ceramic tiles.
- Product calculations should definitely include extra material and a 15% increase in quantity, even 25% for large formats. This is the extra quantity you will need for wall cuts, especially when laying on the bevel, or for unexpected later adjustments.

What is important to do before you start tiling?

- We recommend a quality check of the products before installation. Unpack the cartons and randomly inspect several pieces for surface and dimensional defects or cracks.
- According to the standard it is allowed to find up to 5% of products with visible defects in the quantity of ceramic tiles sold. If there are any defects in the order, these products can be used for cuts or areas that are not visible.
- In any case, if you have any doubts about the quality of the products, make use of the warranty and contact the retailer from whom you purchased them. If it is a brick-and-mortar shop, make a complaint record. We recommend that you purchase the goods from an authorised RAKO store, which is contractually obliged to resolve the complaint and the manufacturer has a direct influence on it. In case of purchase from the manufacturer via the e-shop, use the complaint form, which can be downloaded at www.rako.cz. The warranty does not cover wear and tear caused by use and defects caused by improper handling.

- Check the product batch on the carton, it should be the same on all cartons. The batch gives information about the colour shade and size. Never mix production batches with different shades or sizes on one tiled surface.
- The colour shade is indicated by a two- or three-digit code. The second position of the two-digit code (FA) determines the colour shade (A-V, centre K). For the three-digit code (7P4), the third position (1-9, centre 5) determines the colour shade. The dimensions of the product in millimetres are then determined by a one-digit code (e.g. 8). For example, a 30 × 60 cm product has an exact size of 298 × 598 mm. In the case of rectified/edged products, the same batch is printed on the edges as on the cartons.
- The batch is not only important for designing the paving with the same joint and keeping the same colour shade of the paving, but also if additional goods must be purchased later.
- Before laying the tiles, we recommend that you remove the individual tiling elements from several cartons and compose the resulting surface according to the inspirational photo documentation from the RAKO catalogues or according to the www.rako.cz website.
- Entrust tiling work to an established professional company. If you plan to be tiling yourself, stick to a system solution that offers proven practices, see www.rakosystem.cz.

Why is it a good idea to keep your packaging and leftover material?

We definitely not only recommend keeping goods receipts and cartons, but also leftover tiles. In the case of subsequent purchases of products you will need the batch information on the packaging. Store goods in a dry place and protect them from frost.



12. CERTIFICATION OF PRODUCTS, QUALITY MANAGEMENT SYSTEM, AND ECOLOGICAL EVALUATION

RAKO constantly monitors the quality of its products. A quality management system for products and services has been developed in accordance with the international standard ISO 9001:2016. This management system has been regularly reviewed by the accredited company, which has also issued the certificate of compliance according to CSN EN ISO 9001:2016.

RAKO products have been regularly reviewed by the independent accredited testing laboratory **Technický a zkušební ústav stavební Praha**, (Technical and Building Institute in Prague) to verify conformity of tiles properties based on the regulation of the European Parliament and EU Council No. 305/2011.

In addition, products and minerals are regularly reviewed by an independent testing laboratory for radiation-hygienic safety in agreement with the Decree issued by the State Office for Nuclear Safety No. 422/2016 Coll., within the definitions of Act No. 263/2016 Coll., which insures the measurement of natural radionuclides in final products.

Based on these documents, the following declarations on properties according to the European directives have been issued for customers.

A/ DECLARATION OF PERFORMANCE AND DECLARATION OF CONFORMITY

1/ Verification of stability of ceramic tiles properties according to the regulation of the European Parliament and EU Council No. 305/2011, dated 9th March 2011, Evaluation system 4:

Floor tiles with water absorption less than or equal 0.5 %

Declaration of performance No.: T 21 01 (valid from 1. 11. 2021)

(replaces the previous one performance 7 13 01, T 18 01, D 13 01, D 18 01 and G 13 01)

Wall tiles with water absorption higher than 10%

Declaration of performance No.: W 13 01 (valid from 1. 11. 2021)

Floor tiles - Starline Granit, Graniti

Declaration of performance No.: T 21 02 (valid from 1. 11. 2021)

2/ The stableness of the properties of ceramic and glass mosaics and that of ceramic shaped tiles has been tested in accordance with the provisions of Act No. 22/1997 Coll. on technical requirements on products in conjunction with Government Regulation No. 163/2002, as amended by Government Regulation No. 312/2005 Coll.

Mosaik

Declaration of conformity No.: P 01 – wall tiles

Declaration of performance No.: M 17 01 - floor tiles (valid from 1. 11. 2021)

Ceramic relief listellos

Declaration of conformity No.: P 04

Shaped ceramic bricks, step tiles, etc.

Declaration of conformity No.: P 02

B/ CZECH CERTIFICATES AND BUILDING TECHNICAL ATTEST (STO)

The certificates and building technical attests (STO) issued by the accredited testing laboratory No. 204 TZUS in Pilsen confirm compliance of the ascertained properties of RAKO ceramic tiles with the requirements of **EN 14 411** and related regulations for the following products:

Certificates

Certificate for ceramic tiles, dry pressed with water absorption over 10 % declared according to CSN EN 14 411, Group BIII, Annex L

Certificate for ceramic tiles, dry pressed with water absorption to 0.5 % declared according to CSN EN 14 411, Group BIa, Annex G

Certificate for ceramic tiles, dry pressed with water absorption 0,5 % < E ≤ 3 %, declared according CSN EN 14 411, Group BIb, Annex H

Building technical attests (STO)

(in harmony with Act No. 22/1997 Coll., pursuant to Government Regulation No. 163/2002 Coll., as amended by Government Regulation No. 312/2005 Coll., Government Regulation No. 215/2016 Coll.)

STO No.: 030 - 059826 - mosaic

STO No.: 030 - 059824 - ceramic shaped pieces

STO No.: 030 - 060753 - ceramic relief listellos and ceramic accessories for interior wall tiling

STO No.: 030 - 057478 - ceramic tiling or the blind and weak-sighted

C/ FOREIGN CERTIFICATES OF PRODUCTS

Compliance of properties of RAKO products with applicable standards on the respective territories has also been confirmed by certificates for the following countries:

FRANCE
RUSSIAN
UKRAINE

D/ QUALITY MANAGEMENT SYSTEM CERTIFICATE

A CQS certificate of the quality management system under CSN EN ISO 9001:2016 for the process, design, development, manufacture, and sale of ceramic tiles, and trading activities with additional product lines, including customer service at LASSELSBERGER, s.r.o., was issued on 30th June 2019 by the certification authority – the Czech Association for Quality Certification (CQS) in Prague.

E/ ENVIRONMENTAL PRODUCT DECLARATION (EPD)

The design of the packaging and packaging materials used are adapted to their purpose as much as possible to protect and secure the products - ceramic wall and floor tiles - from damage during handling and transport, provide the necessary information about the product, and minimise the volume of waste generated by the product packaging material. Proper recycling of both the packaging waste and ceramic tile offcuts generated during installation is essential for the minimisation of any environmental impact. It is also possible to recycle old wall and floor tiles at the end of the product's life cycle. The packaging material label pictograms should be followed for disposal. In principle, our products are packed in paper cartons coated with plastic film, fixed with plastic tape, and placed on a wooden EUR pallet. All the packaging materials are fully recyclable. Both the ceramic tiles and offcuts produced during installation are inert and non-toxic. Ceramic waste generated during installation or during the removal of old ceramic wall and floor tiles can be used for backfilling construction pits and, after crushing, as base and filling material in other construction works. In the case of disposal of waste arising from ceramic tiles, proceed in accordance with the relevant Safety Data Sheet and local regulations on construction waste disposal.



Environmental Product Declaration (EPD) as per ISO 14 025 and EN 15 804.

The strategy of LASSELSBERGER, s.r.o. is to produce environmentally friendly products that meet applicable national and international standards and utilize environmentally friendly control systems. RAKO (brand of Lasselsberger group) products and services meet the criteria of EU Ecolabel. By releasing the environmental product declaration (EPD) as per ISO 14 025 and EN 15 804, LASSELSBERGER, s. r. o. has committed to adhering to the environmental requirements.



Declaration of the manufacturer regarding environmental parameters derived from the LCA (life-cycle assessment): Products system and system boundaries, see Table 8.

Table 8

Information about the product system boundaries – information modules (X = included, MNR = module is not relevant)																
Production phase			Construction phase		Usage phase							Life cycle phase				Additional information beyond the life cycle
Delivery of minerals	Transport	Production	Transport on site	Construction / installation process	Usage	Maintenance	Repair	Replacement	Reconstruction	Operational energy consumption	Operational water consumption	Demolition / deconstruction	Transport	Waste treatment	Removal	Benefits and costs beyond the system boundary. Potential of re-use, recovery and recycling
A1	A2	A3	A4	A5	B1	B2	B3	B4	B5	B6	B7	C1	C2	C3	C4	D
X	X	X	X	X	MNR	X	MNR	MNR	MNR	MNR	MNR	MNR	X	X	X	X

Parameters describing environmental impacts.

Scan QR code to view or download actual parameters at www.rako.eu.

All to the information supplementing the building assessment as per LEED and BREEAM are available from the quality manager of LASSELSBERGER, s.r.o.

F/ ENERGY MANAGEMENT SYSTEM CERTIFICATE

The energy management system certificate under CSN EN ISO 50001, the objective of which is to optimise the use of energy in the production process and in non-production areas, to constantly reduce energy demand, and increase energy efficiency. The certificate was issued on 30th June 2016.

G/ LEED AND BREEAM

LASSELSBERGER, s.r.o. issued a publication titled "Ceramic tiles – Possibility to Meet the LEED and BREEAM Criteria for the Complete Assessment of Buildings". The company confirms in this publication that it is able to meet these criteria.

A confirmation of conformity with the requirements for these products appears on each delivery note of the manufacturer.

Information lines:

Tel.: +420 800 303 333

E-mail: info@rako.cz

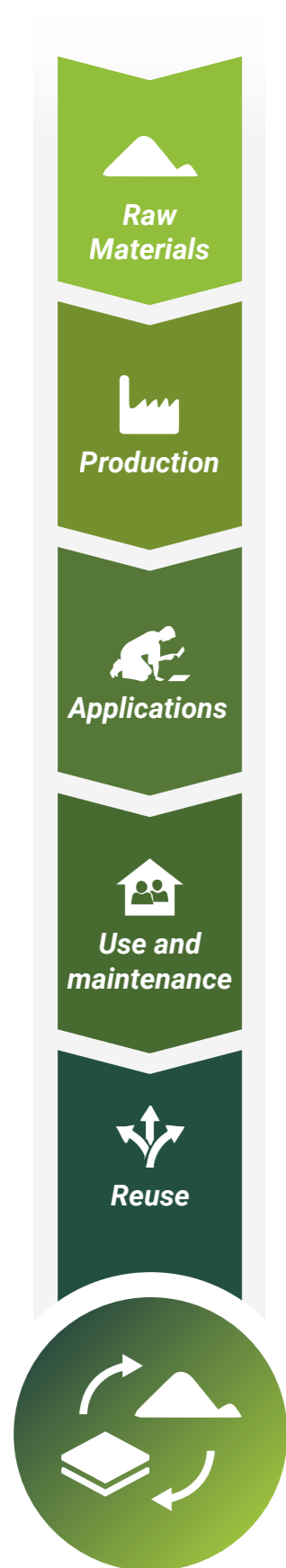

Raw Materials

We use more than 95% of our own raw materials from local natural resources. We reuse, recycle or renew resources and materials.

Production

Resource efficiency is the key to our production. We reduce our electricity, gas, and water consumption as much as possible. We use raw materials to the maximum with minimum waste. We have reduced our emissions with efficient filters.

Applications

Our wall tiles are supplied in corrugated cardboard packaging that is fully recyclable. Shipping packaging materials such as plastic foil and tape are recyclable as well.

Use and maintenance

Ceramic tiles do not release any chemicals or vapours into the environment, are non-toxic and pose no health risk in any interior environment.

Reuse

We recycle ceramic waste, fulfilling the circular policy concept. We use milled tiles to substitute some raw materials. We return unfired shards and dust from filters to processing.

13. WARRANTY CONDITIONS

The manufacturer, LASSELSBERGER, s.r.o. Pilsen, provides for all its ceramic tiles a

2-year warranty

or the properties defined by EN 14411.

The warranty shall apply only whilst observing the recommendations regarding proper storage, handling, use, and installation; see the Information sheet about products manufactured by LASSELSBERGER, s.r.o., download at www.rako.eu.

It does not apply to defects caused by improper handling, improper cleaning, and natural hazards (earthquakes, floods, fire, etc.).

Provided a customer receives products whose properties fail to meet the agreed quality, then the customer is entitled to claim these products. In doing so, a specific procedure must be met. All claims regarding product liability must be made immediately in writing, and submitted to the direct supplier – retailer.

For visible defects (sizes, flatness, glaze defects, shades, and type confusion), the claim must be made for the goods sent in original packaging, and **before starting the laying work**.

If you have any questions about the RAKO products, please contact our Information line:

Information channels of the Information line:

Tel.: +420 800 303 333

E-mail: info@rako.cz

Internet: www.rako.eu

since 1883



Complete **Ceramic** Solution

LASELSBERGER, s.r.o.
Adelova 2549/1 | 320 00 | Plzeň
Czech Republic | T: +420 800 303 333
E: info@rako.cz | www.rako.eu

2024