

serie classic

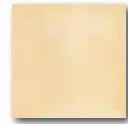

15x15



WAA1B350
○ 68 / m²
mat | matt

15x15
45x15



WIT1B261
○ 28 / ks
mat | matt



WIT1B259
○ 28 / ks
mat | matt



WIT1B260
○ 28 / ks
mat | matt



WITP2001 (SET)
○ 52 / set
mat | matt

15x2



WLRC2010
○ 38 / ks
mat | matt

30x30



WIT32258 (SET)
○ 52 / set
mat | matt

45x30



WIT1B043 (SET)
○ 78 / set
mat | matt



WITP4035 (SET)
○ 76 / set
mat | matt



WITP4042 (SET)
○ 76 / set
mat | matt

béžová / beige / beżowa / бежевый / beige



30x30



DAR34713
Via
PEI 4 ○ 74 / m²
mat | matt
hnědá / brown / brązowa / коричневый / marrón

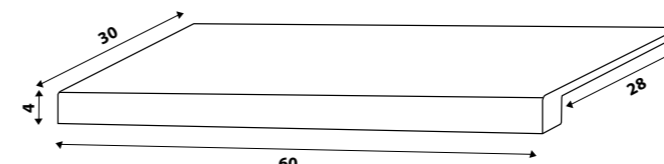

30x60 (Rock, Stones)
průběžná / continuous / bieżaca / непрерывный элемент

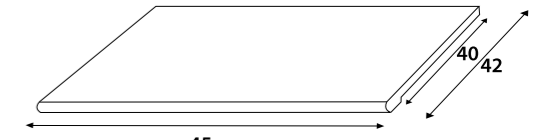

45x42 (Defile)
průběžná / continuous / bieżaca / непрерывный элемент

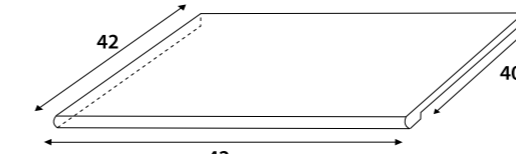

42x42 (Defile)
roh levý / left corner / róg lewy / левый угол

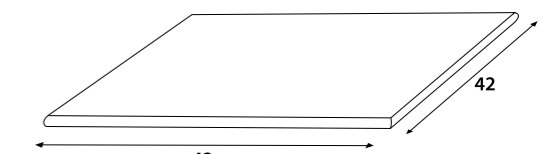

42x42 (Defile)
roh pravý / right corner / róg prawy / правый угол

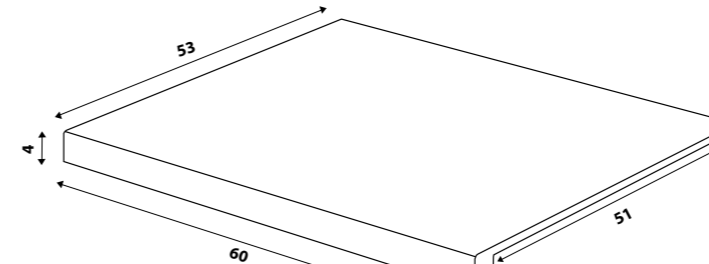

60x53 (Alba, Random)
průběžná / continuous / bieżaca / непрерывный элемент

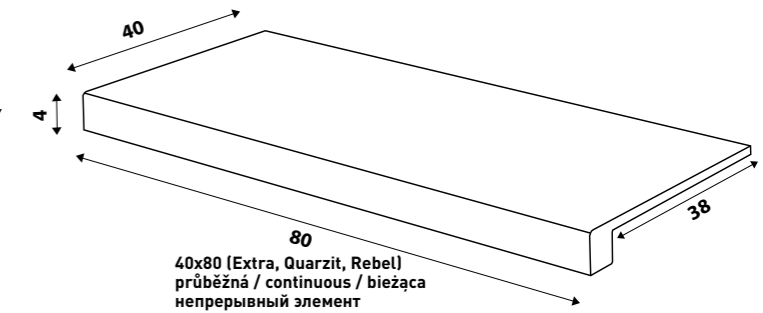

40x80 (Extra, Quarzit, Rebel)
průběžná / continuous / bieżaca / непрерывный элемент

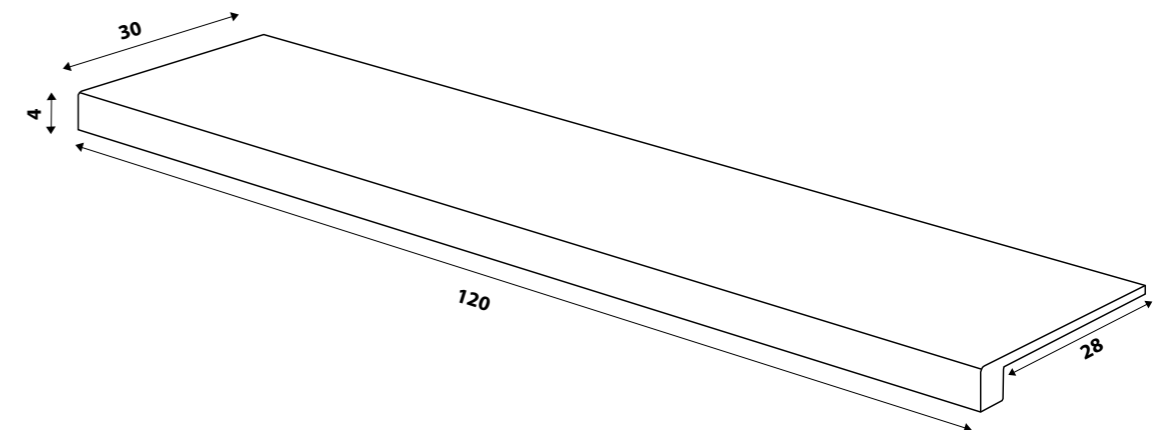

120x30 (Board, Saloon)
průběžná / continuous / bieżaca / непрерывный элемент / folymatos

výrobek / product	cm	mm	EN	ks/m ²	m ²	m ²	kg	kg/m ²	brutto kg	
obkládačka / wall tile	15x15	150x150x6	EN 14411:2016, annex L BIII GL	44	44	1,00	100	100,00	10,5	1 075
inzerťo / insert	15x15	150x150x6	EN 14411:2016, annex L BIII GL	4	44	0,09	-	-	1,0	10,5
inzerťo / insert (set)	45x15	450x150x6	EN 14411:2016, annex L BIII GL	2	44	0,14	-	-	1,6	11,7
reliefní listela / relief listel	15x2	150x20	STO č. 030 - 054498	24	333	0,07	-	-	1,3	17,7
inzerťo / insert (set)	30x30	300x300x6	EN 14411:2016, annex L BIII GL	1	44	0,09	-	-	1,0	10,5
inzerťo / insert (set)	45x30	450x300x6	EN 14411:2016, annex L BIII GL	1	44	0,14	-	-	1,4	10,5
dlaždice / floor tile	33x33	333x333x8	EN 14411:2016, annex G BIIa GL	12	9	1,33	44	58,52	23,6	1 061