





60x120

R9

A

V3

R

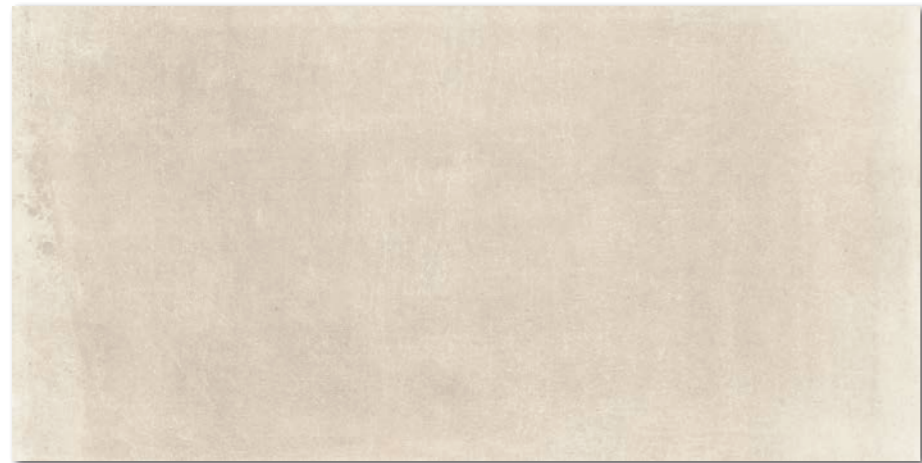

DAKV1743  
PEI 5 ○ 700 l m<sup>2</sup>  
matt  
beige | beige



DAKV1740  
PEI 5 ○ 700 l m<sup>2</sup>  
matt  
weiß-grau | white-grey

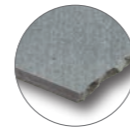
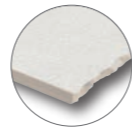

60x120

R9

A

V3

R



DAKV1741  
PEI 5 ○ 700 l m<sup>2</sup>  
matt  
grau | grey



DAKV1742  
PEI 4 ○ 700 l m<sup>2</sup>  
matt  
dunkelgrau | dark grey

Produkt | product



60x120



598x1198x10



EN 14411 - G Bla



2



1,4



1,44



27



38,88



32,7



22,7



908

Bodenfliese | floor tile



80x80  
R9  
A  
V3  
R

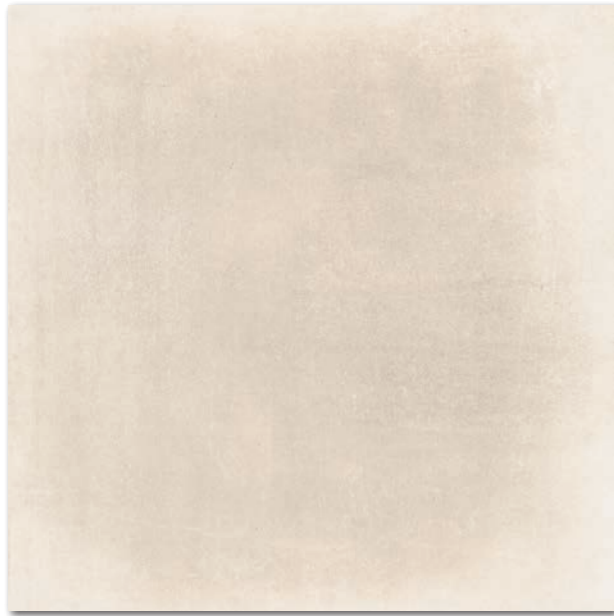

DAK81743  
PEI 5 ○ 700 l m<sup>2</sup>  
matt

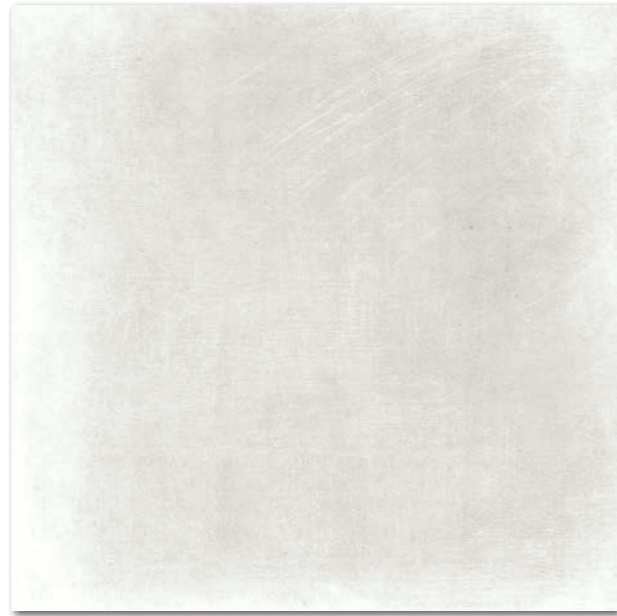

DAK81740  
PEI 5 ○ 700 l m<sup>2</sup>  
matt



80x80  
R9  
A  
V3  
R

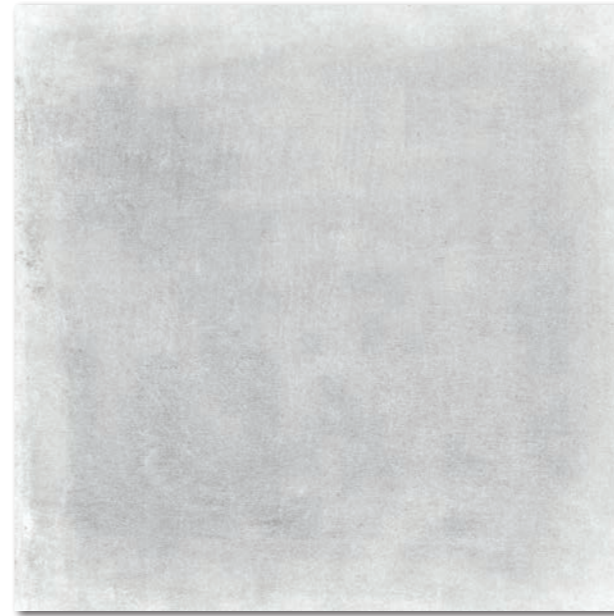

DAK81741  
PEI 5 ○ 700 l m<sup>2</sup>  
matt

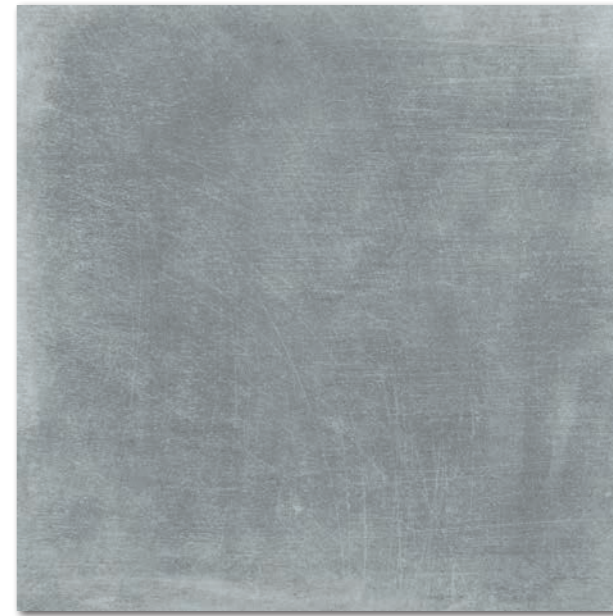

DAK81742  
PEI 4 ○ 700 l m<sup>2</sup>  
matt

40x80  
R9  
A  
V3  
R



DAK84743  
PEI 5 ○ 720 l m<sup>2</sup>  
matt

beige | beige



DAK84740  
PEI 5 ○ 720 l m<sup>2</sup>  
matt

weiß-grau | white-grey

40x80  
R9  
A  
V3  
R



DAK84741  
PEI 5 ○ 720 l m<sup>2</sup>  
matt

grau | grey



DAK84742  
PEI 4 ○ 720 l m<sup>2</sup>  
matt

dunkelgrau | dark grey

Produkt | product



Produkt   product	cm	mm	EN	tile	St/m <sup>2</sup>	m <sup>2</sup>	tile	m <sup>2</sup>	kg	kg/m <sup>2</sup>	brutto kg
Bodenfliese   floor tile	80-80	798-798-10	EN 14411 - G Bla	2	1,6	1,28	42	53,76	28,0	21,9	1 202
Bodenfliese   floor tile	40-80	398-798-10	EN 14411 - G Bla	4	3,1	1,28	42	53,76	28,0	21,9	1 202

Empfohlene Formatkombinationen siehe Seite 484-485. | Recommended combinations of modular sizes see pages 484-485.



60x60  
R9  
A  
V3  
R

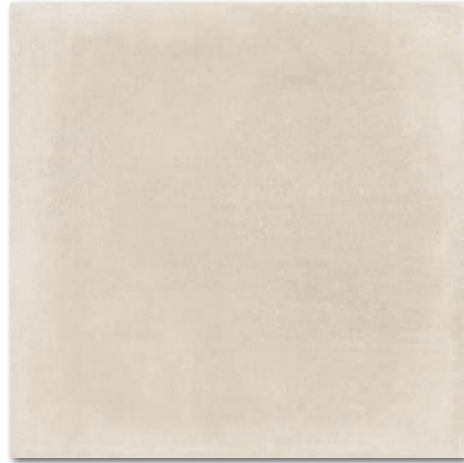

DAK63743  
PEI 5 ○ 560 l m<sup>2</sup>  
matt



DAK63740  
PEI 5 ○ 560 l m<sup>2</sup>  
matt



DAK63741  
PEI 5 ○ 560 l m<sup>2</sup>  
matt

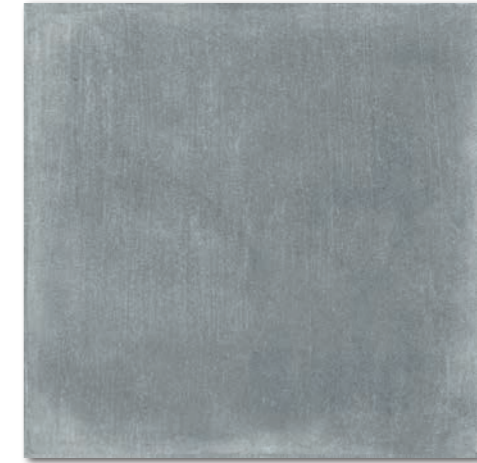

DAK63742  
PEI 4 ○ 560 l m<sup>2</sup>  
matt



60x60  
R9  
A  
V3  
R

30x60  
R9  
A  
V3  
R



DAKSE743  
PEI 5 ○ 540 l m<sup>2</sup>  
matt

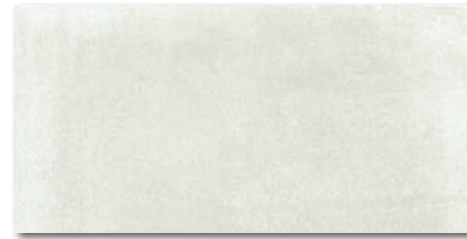

DAKSE740  
PEI 5 ○ 540 l m<sup>2</sup>  
matt



DAKSE741  
PEI 5 ○ 540 l m<sup>2</sup>  
matt



DAKSE742  
PEI 4 ○ 540 l m<sup>2</sup>  
matt

30x60  
R9  
A  
V3  
R

45x45  
R9  
A  
V3



DAA4H743  
PEI 5 ○ 510 l m<sup>2</sup>  
matt  
beige | beige



DAA4H740  
PEI 5 ○ 510 l m<sup>2</sup>  
matt  
weiß-grau | white-grey



DAA4H741  
PEI 5 ○ 510 l m<sup>2</sup>  
matt  
grau | grey



DAA4H742  
PEI 4 ○ 510 l m<sup>2</sup>  
matt  
dunkelgrau | dark grey

45x45  
R9  
A  
V3

Produkt   product	cm	mm	EN	Stk	Stk/m <sup>2</sup>	m <sup>2</sup> /Stk	Stk/m <sup>2</sup>	kg/m <sup>2</sup>	kg/m <sup>2</sup>	brutto kg
Bodenfliese   floor tile	60x60	598x598x10	EN 14411 - G Bla	3	2,8	1,08	32	34,56	23,7	782
Bodenfliese   floor tile	30x60	298x598x10	EN 14411 - G Bla	6	5,6	1,08	40	43,20	23,7	971
Bodenfliese   floor tile	45x45	448x448x8	EN 14411 - G Bla	6	5	1,21	34	41,14	21,1	741

Empfohlene Formatkombinationen siehe Seite 484-485. | Recommended combinations of modular sizes see pages 484-485.

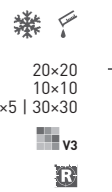
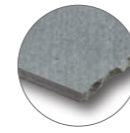

DAK26743  
PEI 5 ○ 780 | m<sup>2</sup>  
matt | R9 | A |

beige | beige



DDT26743  
○ 190 | St  
mattglossy |



DAK12743 [SHEET]  
PEI 5 ○ 970 | m<sup>2</sup>  
matt | R10 | B |



DDM06743 [SHEET]  
PEI 5 ○ 440 | Netz  
matt | R10 | B |



DAK26740  
PEI 5 ○ 780 | m<sup>2</sup>  
matt | R9 | A |

weiß-grau | white-grey



DDT26740  
○ 190 | St  
mattglossy |



DAK12740 [SHEET]  
PEI 5 ○ 970 | m<sup>2</sup>  
matt | R10 | B |



DDM06740 [SHEET]  
PEI 5 ○ 440 | Netz  
matt | R10 | B |



DAK26741  
PEI 5 ○ 780 | m<sup>2</sup>  
matt | R9 | A |

grau | grey



DDT26741  
○ 190 | St  
mattglossy |



DAK12741 [SHEET]  
PEI 5 ○ 970 | m<sup>2</sup>  
matt | R10 | B |

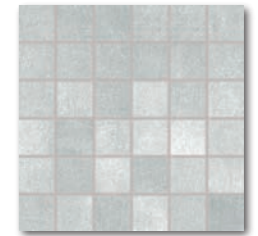

DDM06741 [SHEET]  
PEI 5 ○ 440 | Netz  
matt | R10 | B |



DAK26742  
PEI 4 ○ 780 | m<sup>2</sup>  
matt | R9 | A |

dunkelgrau | dark grey



DDT26742  
○ 190 | St  
mattglossy |



DAK12742 [SHEET]  
PEI 4 ○ 970 | m<sup>2</sup>  
matt | R10 | B |



DDM06742 [SHEET]  
PEI 4 ○ 440 | Netz  
matt | R10 | B |

Produkt   product	cm	mm	EN	St/m <sup>2</sup>	m <sup>2</sup>	m <sup>2</sup>	kg	kg/m <sup>2</sup>	brutto kg		
Bodenfliese   floor tile	20×20	197×197×10	EN 14411 - G Bla	23	25	0,92	57	52,44	20,1	21,9	1 174
Dekor   decor	20×20	197×197×10	EN 14411 - G Bla	3	25	0,12	-	-	2,6	21,9	-
Bodenfliese   floor tile	10×10	98×98×10	EN 14411 - G Bla	10	11	0,91	56	50,96	19,9	21,9	1 142
Mosaik sheet 30×30 cm   mosaic sheet 30×30 cm	5×5	48×48×10	EN 14411 - G Bla	3	11	0,27	-	-	5,9	21,9	-

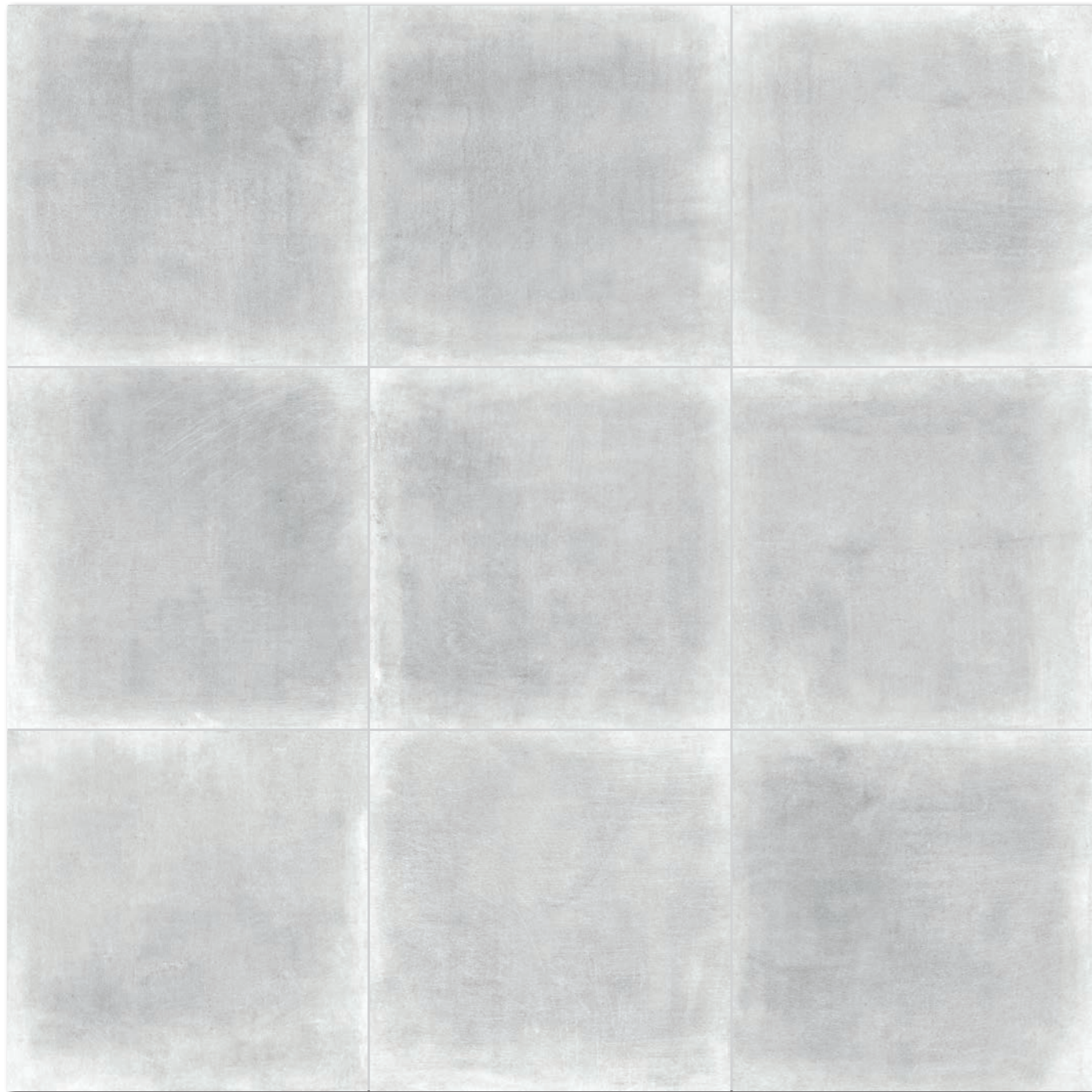

Die Fliesen der Serie zeichnen sich durch ein breites Farbspiel V3 aus. | All products of the entire batch show big deviations in shade difference V3.

Wir empfehlen, einzelne Fliesen aus mehreren Paketen herauszunehmen und den gesamten Bodenbelag nach der Inspirationsfotodokumentation in den Katalogen RAKO, eventuell den Webseiten [www.rako.eu](http://www.rako.eu), zu komponieren. Wünschenswert ist die Kombination aller Fliesendesigns einschließlich ihrer Drehung um 90° oder 180°, sodass ausgewogene Optik der verlegten Fläche erzielt wird.

Before laying the tiles, we suggest you select from several cartons and arrange them as illustrated in the inspiration photo documentation in RAKO catalogues or website [www.rako.eu](http://www.rako.eu), and mix the tiles to achieve the required result including turning them by 90° or 180°.

Produkt   product	cm	mm	EN		St/m <sup>2</sup>	m <sup>2</sup>			kg	kg/m <sup>2</sup>	brutto kg
Stufe   step tile	30x120	298x1198x10	STO No. 030 - 059824	3/5	2,8	1,08/1,8			24,6/40,9	22,7	-
Stufe   step tile	40x80	398x798x10	STO No. 030 - 059824	2	3,1	0,64	-	-	14,1	21,9	-
Stufe   step tile	30x60	298x598x10	STO No. 030 - 059824	6	5,6	1,08	40	-	23,7	21,9	-
Sockel   skirting plinth	80x9,5	798x95x10	STO No. 030 - 059824	10	13,2	0,76	-	-	16,7	21,9	-
Sockel   skirting plinth	60x9,5	598x95x10	STO No. 030 - 059824	13	17,5	0,74	-	-	16,2	21,9	-
Sockel   skirting plinth	45x8,5	448x85x8	STO No. 030 - 059824	25	26,1	0,96	-	-	16,7	17,4	-
Stufenformteil   special step tile	40x80	398x798x10	STO No. 030 - 059824	2	-	-	-	-	-	-	-
Stufenformteil   special step tile	30x120	298x1198x10	STO No. 030 - 059824	2	-	-	-	-	-	-	-

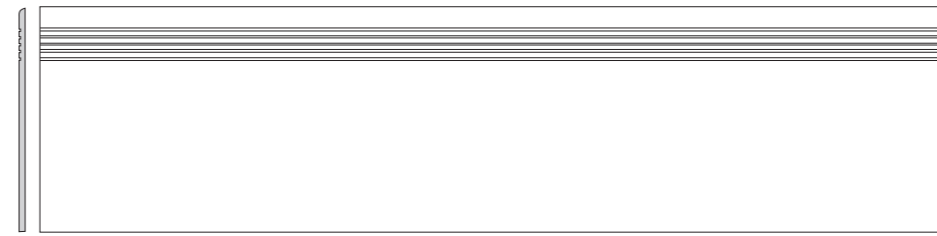

DCPVF740 weiß-grau | white-grey  
 DCPVF741 grau | grey  
 DCPVF742 dunkelgrau | dark grey  
 DCPVF743 beige | beige  
 PEI 4-5 ○ 840 | St  
 matt

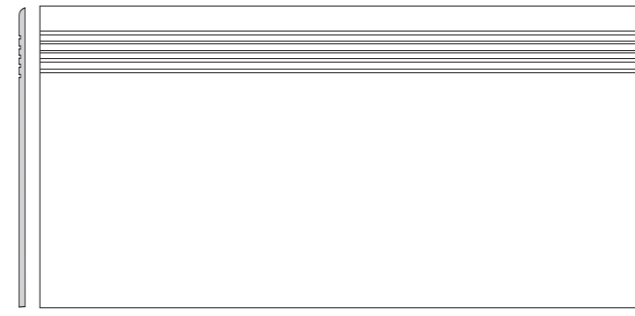

DCP84740 weiß-grau | white-grey  
 DCP84741 grau | grey  
 DCP84742 dunkelgrau | dark grey  
 DCP84743 beige | beige  
 PEI 4-5 ○ 490 | St  
 matt

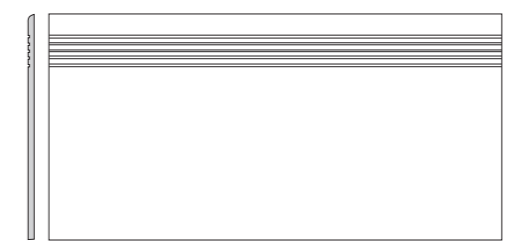

DCPSE740 weiß-grau | white-grey  
 DCPSE741 grau | grey  
 DCPSE742 dunkelgrau | dark grey  
 DCPSE743 beige | beige  
 PEI 4-5 ○ 370 | St  
 matt

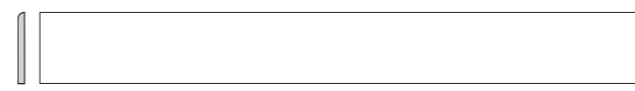

DSA89740 weiß-grau | white-grey  
 DSA89741 grau | grey  
 DSA89742 dunkelgrau | dark grey  
 DSA89743 beige | beige  
 ○ 290 | St  
 matt



DSAS4740 weiß-grau | white-grey  
 DSAS4741 grau | grey  
 DSAS4742 dunkelgrau | dark grey  
 DSAS4743 beige | beige  
 ○ 220 | St  
 matt



DSAPS740 weiß-grau | white-grey  
 DSAPS741 grau | grey  
 DSAPS742 dunkelgrau | dark grey  
 DSAPS743 beige | beige  
 ○ 200 | St  
 matt

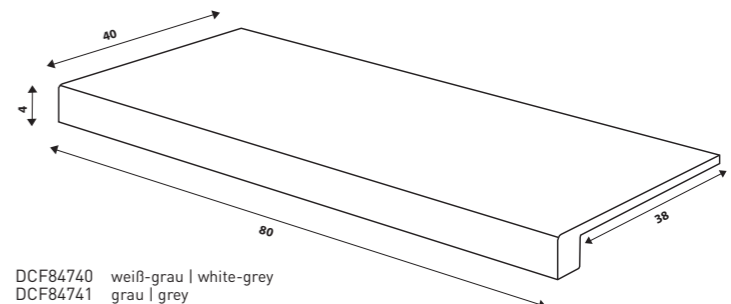

DCF84740 weiß-grau | white-grey  
 DCF84741 grau | grey  
 DCF84742 dunkelgrau | dark grey  
 DCF84743 beige | beige  
 PEI 4-5 ○ 1250 | St  
 matt

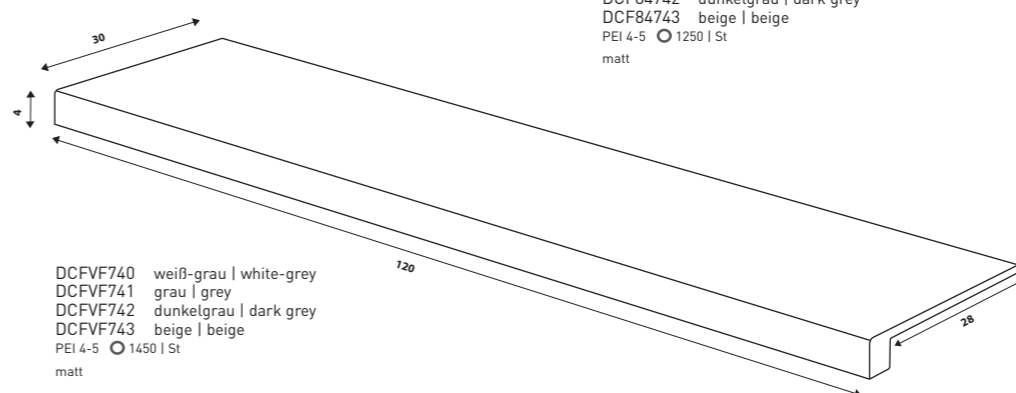

DCFVF740 weiß-grau | white-grey  
 DCFVF741 grau | grey  
 DCFVF742 dunkelgrau | dark grey  
 DCFVF743 beige | beige  
 PEI 4-5 ○ 1450 | St  
 matt



30x120  
 R9  
 A  
 V3  
 R

40x80  
 30x60  
 R9  
 A  
 V3  
 R

80x9,5  
 60x9,5  
 R

45x8,5

40x80  
 R9  
 A  
 V3  
 R

30x120  
 R9  
 A  
 V3  
 R

News